



National Analytical Management Program (NAMP)
U.S. Department of Energy Carlsbad Field Office

Radiochemistry Webinars

Nuclear Fuel Cycle Series

- *Introduction to Pyroprocessing Technology for Used Nuclear Fuel*



In Cooperation with our University Partners



Meet the Presenter...

Dr. Supathorn Phongikaroon



Supathorn Phongikaroon, Ph.D., P.E., is an Associate Professor in Department of Mechanical and Nuclear Engineering at the Virginia Commonwealth University (VCU). Prior joining VCU in 2014, he was an Assistant Professor in the Department of Chemical and Materials Engineering and Nuclear Engineering Program at the University of Idaho, Idaho Falls Campus (2007 – 2013) and was a Radiochemistry Laboratory lead at the Center for Advanced Energy Studies (2011 – 2013). He has over 10 years of experience in high temperature chemical and electrochemical experiments and detection for used nuclear fuel separations and processes.



Currently, he is the lead principle investigator (PI) and co-PI on the 2012, 2013, and 2014 Nuclear Energy University Program (NEUP) projects, respectively, relating to safeguard and material detection and accountability in molten salt for pyroprocessing technology. He has led and collaborated on many electrochemical and chemical separation projects for used nuclear fuel since 2004 with several national and international laboratories and leading universities. He has authored and co-authored more than 20 peer-reviewed publications, and given over 50 presentations about molten salt system at national and international conferences and workshops.

Contact Information: Dr. Supathorn Phongikaroon
sphongikaroon@vcu.edu

Introduction to Pyroprocessing Technology for Used Nuclear Fuel

Dr. Supathorn Phongikaroon, P.E.
Department of Mechanical and Nuclear Engineering
Virginia Commonwealth University



National Analytical Management Program (NAMP)
U.S. Department of Energy Carlsbad Field Office

TRAINING AND EDUCATION SUBCOMMITTEE



Topics to be Covered

- Technology Overview
- Electrorefining
- Thermal Processing
- Ceramic Waste Processing
- Current Direction

Technology Overview

A decorative graphic consisting of a solid green horizontal bar that spans the width of the slide. Below this bar, on the right side, there are several horizontal lines of varying lengths and colors, including shades of green and white, creating a layered, modern look.

Basic Nuclear Fuel Cycle

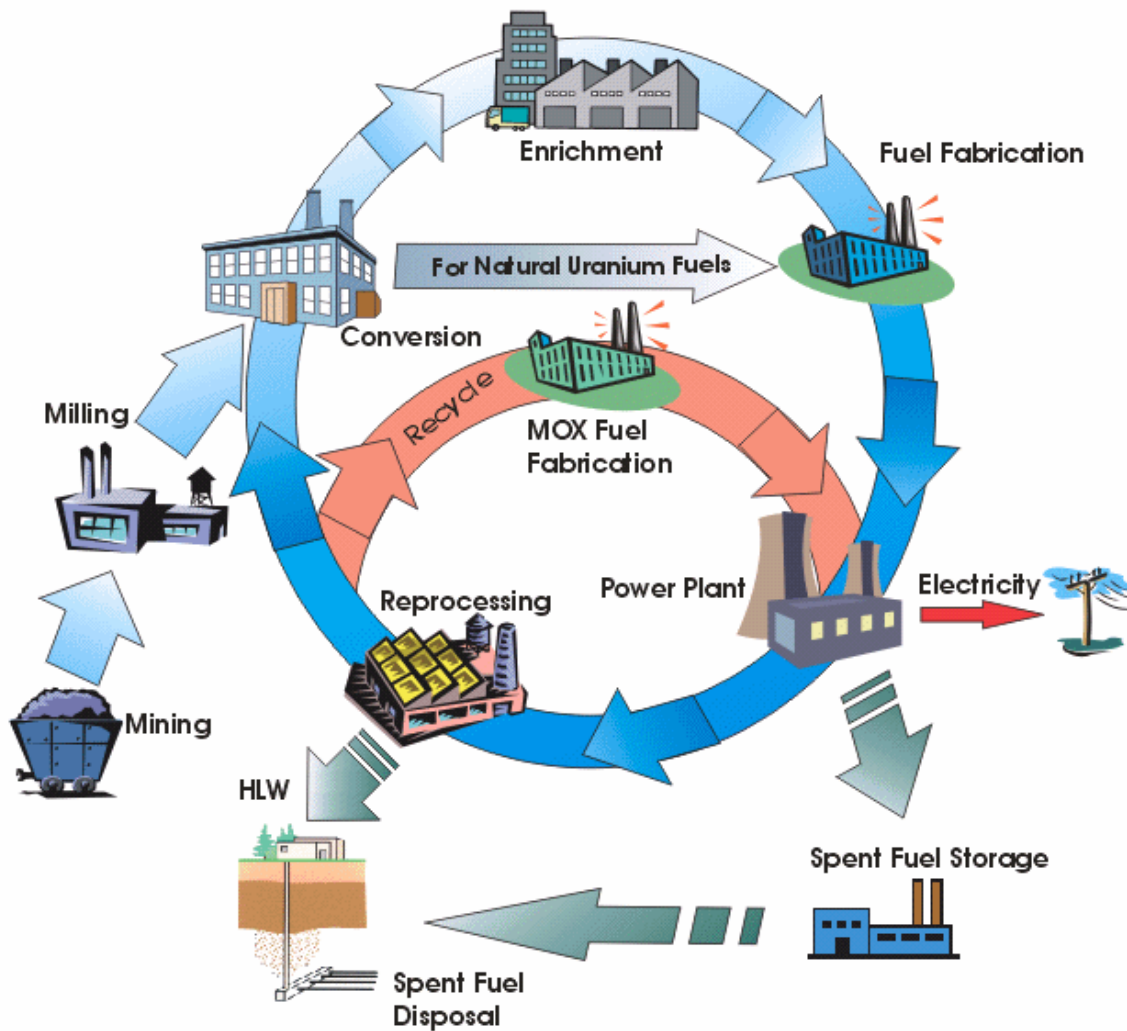

- It starts with the mining of unused nuclear materials from nature and ends with the safe disposal of used nuclear material in nature.

Pyroprocessing Technology (aka Electrochemical or Electrometallurgical Processing)

- Developed at Argonne National Laboratory under the Integral Fast Reactor program in 1980s to provide
 - Compact, on-site used fuel separations and fuel fabrication
 - Efficient handling of sodium bonding
 - Critically-safe conditions for processing high enriched fuel
 - Robust method for processing high burnup fuel (avoid organic solvents)
- General characteristics
 - Dry process, employing molten metals and molten salts
 - High temperature process ($T > 450$ °C)
 - Electrochemical separation of actinides from fission products, cladding, and sodium
 - Conversion of sodium metal to sodium chloride
 - Initially not designed to recover pure Pu (in contrast with PUREX)

Pyroprocessing History

- In 1950s and 1960s, many processes were developed.
 - Slagging and fluxing of molten metals
 - Melt refining or “oxidative slagging”
 - Molten zone refining
 - Extraction of molten metal by immiscible molten metals and salts
- In 1970s, more processes were developed
 - Electrolysis or electrorefining
 - Fluorination and chlorination of oxide materials
 - Direct oxide reduction
 - Molten salt extraction
- Present generation of pyrochemical processing for recycling or treating used fuel started in the 1980s.
 - IFR program for recycle of EBR-II fuel
 - EBR-II Used Fuel Treatment program for fuel stabilization and waste disposal

Experimental Breeder Reactor-II

- EBR-II was a metallic-fueled sodium-cooled, fast reactor.
 - Operated from 1963 to 1995.
 - Uranium-10 wt % zirconium driver fuel.
 - High enrichment driver fuel (67-78%)
 - DU blanket (1% Pu--used for breeding)
 - High burnup (>30 atom %) achieved in some fuel pins.
 - All fuel sodium bonded
- Demonstration test reactor for Integral Fast Reactor System (1984 to 1995).
- Reactor shut down in 1995



22.4 tons blanket
3.1 tons driver

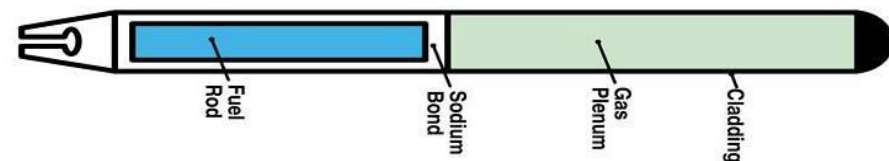

Why Treat Fuel?

- Sodium passivation
 - All fuel assemblies contain sodium which served as a heat transfer medium in the reactor. This sodium is highly reactive with water, thus creating the requirement for fuel treatment prior to disposal.

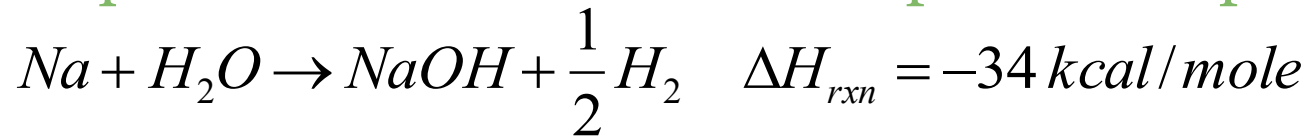

driver fuel pin
cross-section

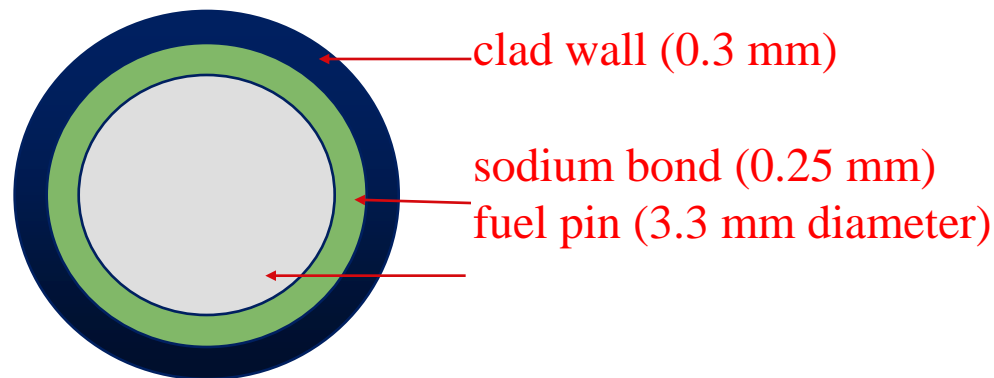

Why Treat Fuel?

- Waste volume minimization
 - Recycle actinides
 - Concentrate fission products into stable waste forms
- Recovery of plutonium and minor actinides
 - TRU recovery should be demonstrated for future applications of pyroprocessing technology
 - Key component of waste management

General Process Description

- Electrorefiner (ER) consisting of molten chloride salt;
- Used fuel loaded into baskets at anode;
- Application of electric current for the dissolution of uranium, transuranics and metal fission products;
- Reduction and recovery of pure uranium at a steel cathode; and
- Uranium-transuranics mixture recovered from secondary cathode (molten cadmium)

Pyroprocessing Vs. Aqueous

	Aqueous Separation Method	Pyrochemical Method
Solution	Aqueous	Ionic liquid
Operating Temperature	Low	High
Process	Continuous	Batch
Product purity	High	Low
Waste Type	LLW	HLW
Waste Volume	Large	Small
Proliferation resistance	No...but safeguardable	Yes
Compactness	No	Yes
Scale-up	Commercial	Engineering (PRIDE, ANL, INL-FCF)

EBR-II Used Fuel Treatment Process

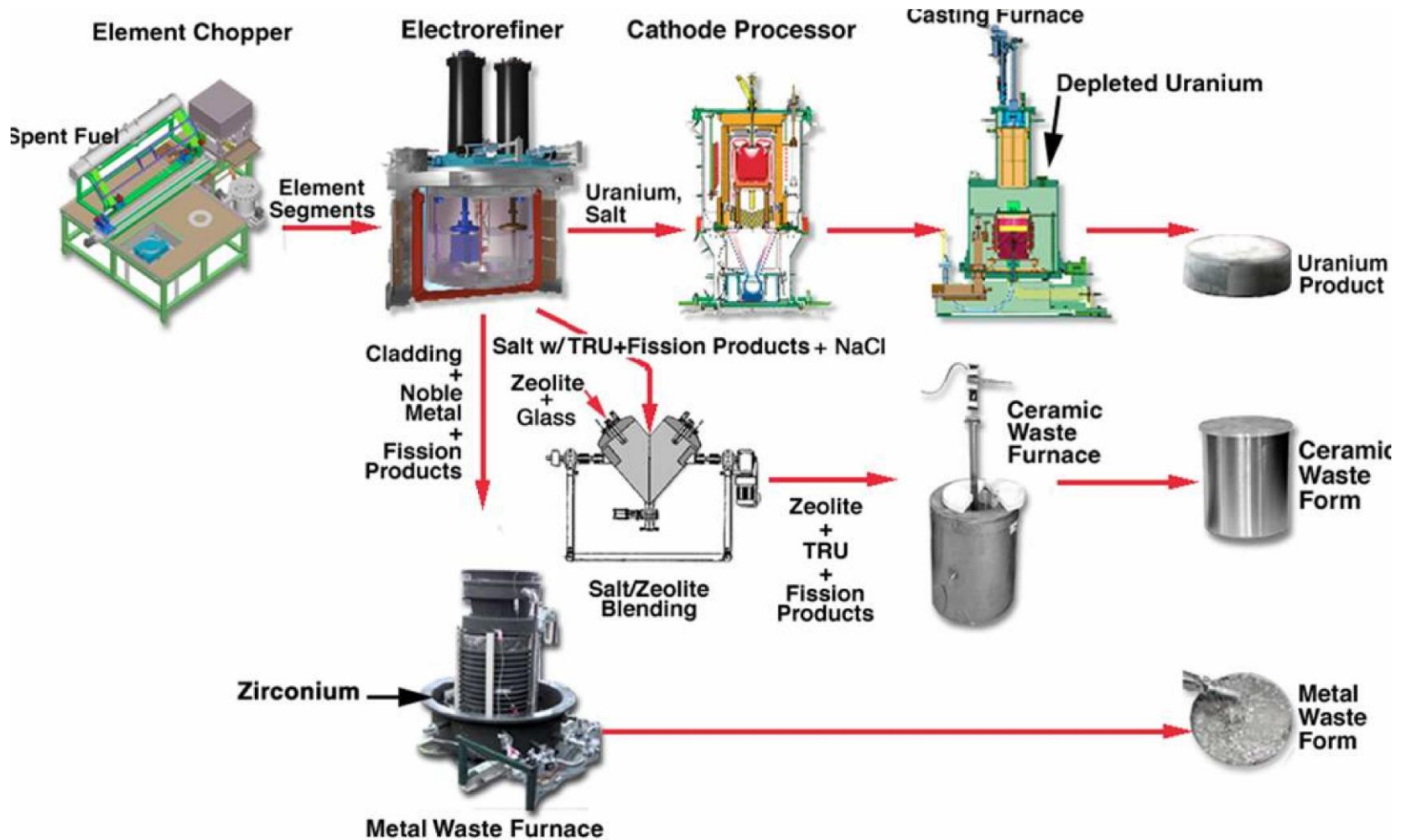

Advanced Conceptual design

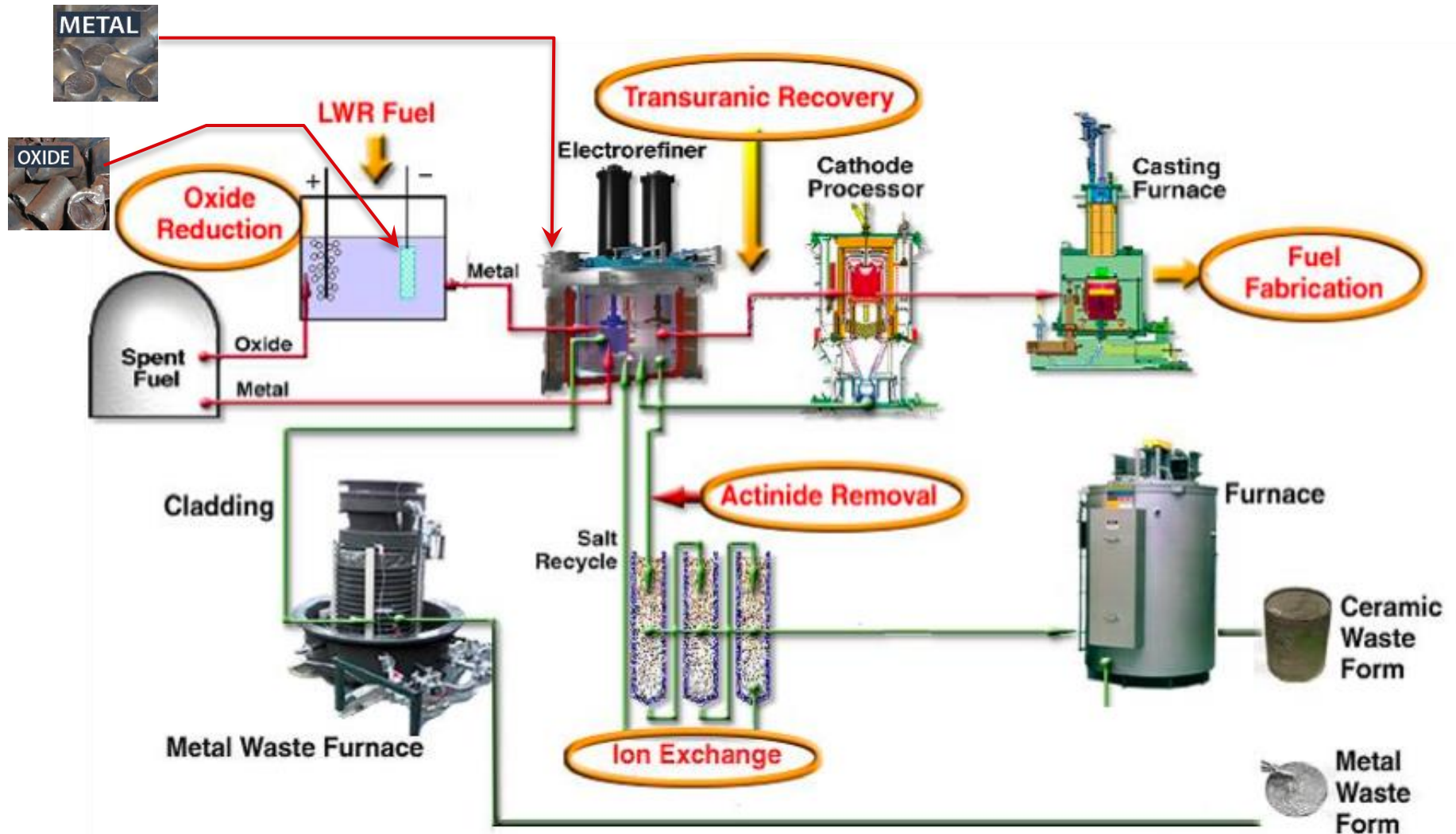

Advantages of Advanced Flowsheet

- Accommodates oxide fuel feed
- Recovers actinides for recycled fuel fabrication
- Reduces high level waste volume
- Improves efficiency of actinide recycle

High-Level Wastes

- Two high-level wastes are produced from pyrochemical processing.
- A sodalite-based ceramic waste stabilizes fission products that form chlorides.
- A stainless-steel-15% zirconium metal waste stabilizes cladding hulls and more noble fission products.



Electrorefining



EBR-II Used Fuel Treatment Process

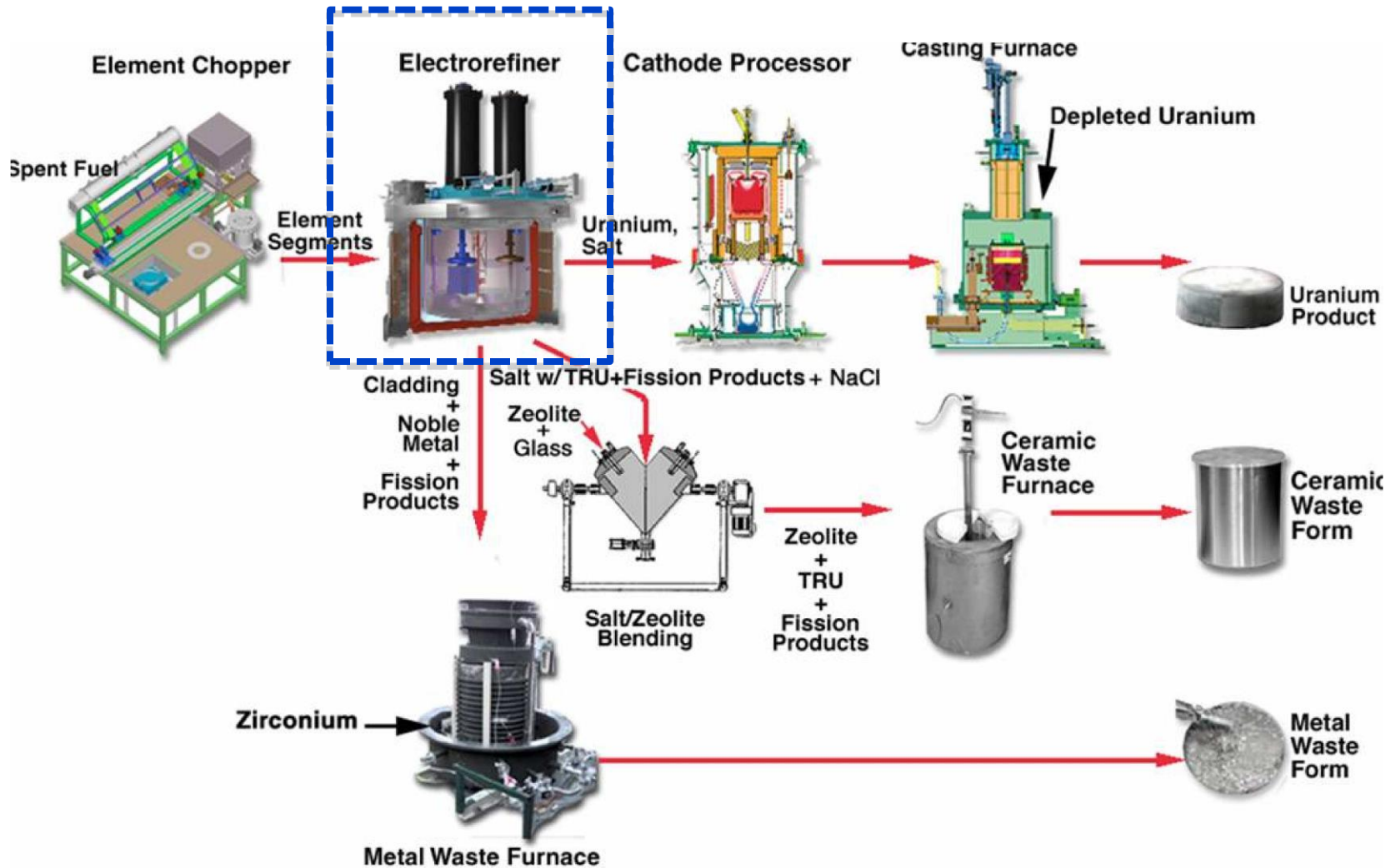

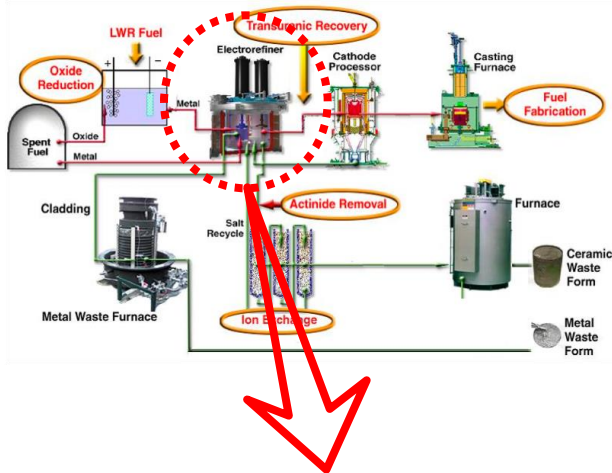

The Heart of Pyroprocessing Tech.



ELECTROREFINER (ER)

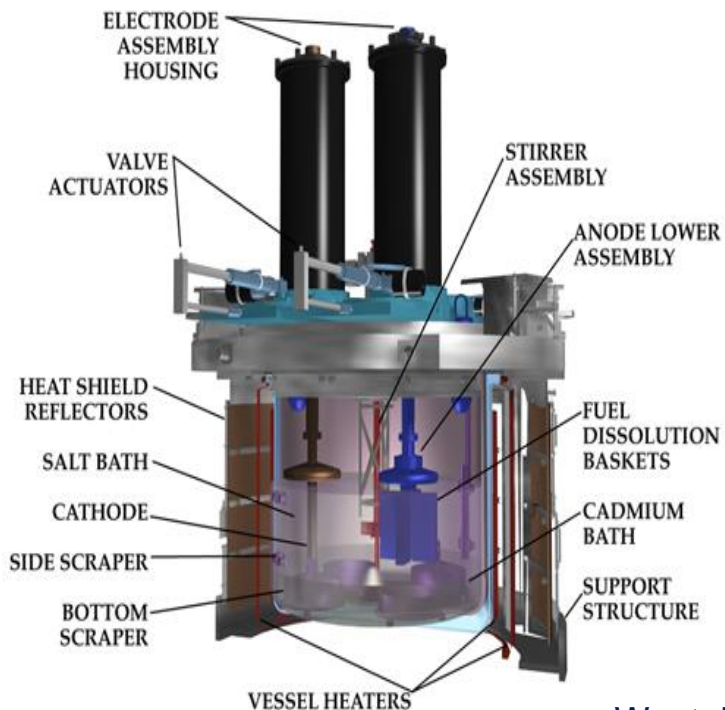

- Runs at high temperature (450-500 °C) with molten LiCl-KCl electrolyte.
- Purified U metal collected on cathode.
- Cadmium chloride is used as an oxidant.
- Cadmium pool captures materials and can be used as an anode for clean-up.

General Schematic Drawing

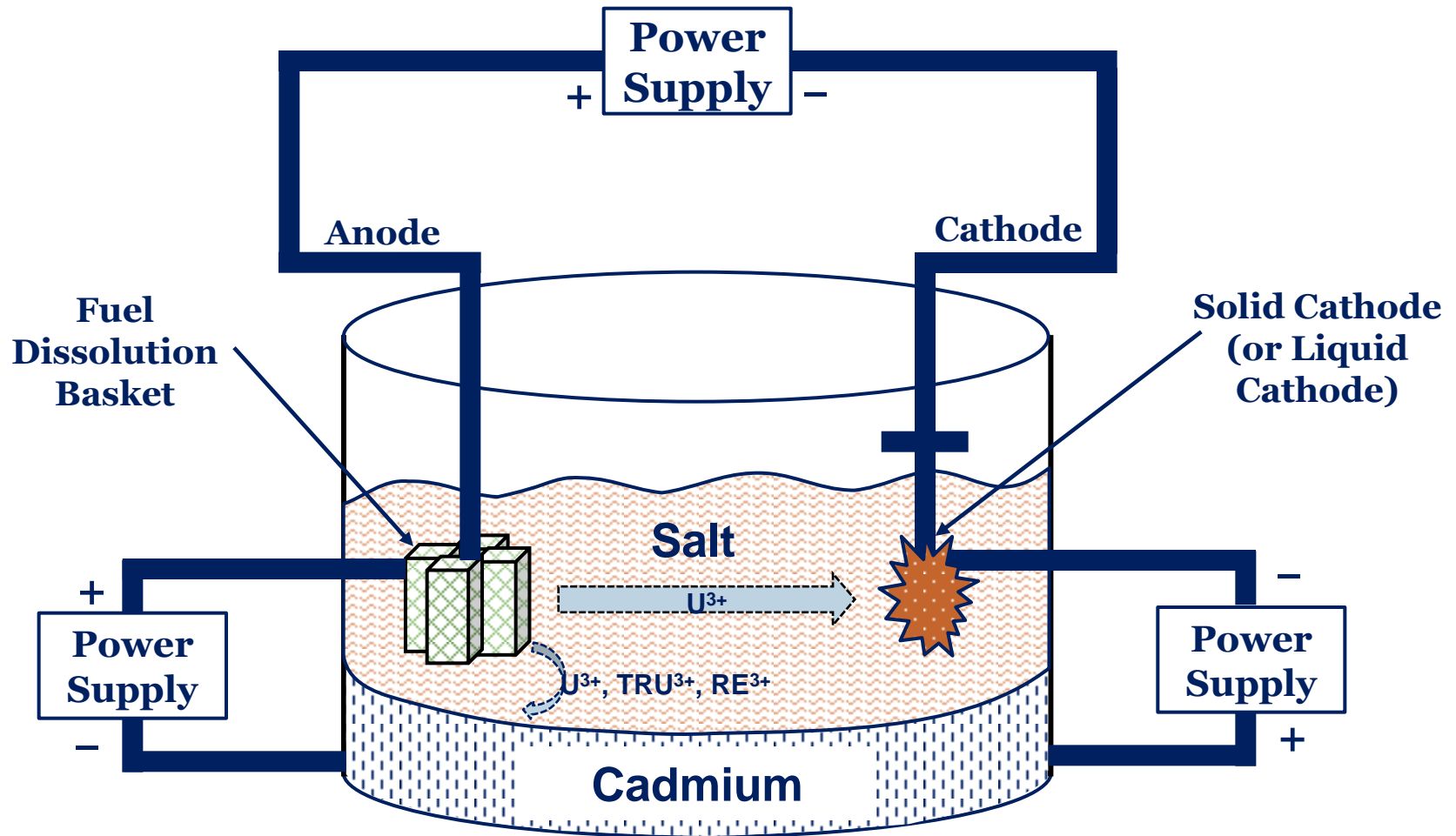

Chemistry in ER at 500 °C

Chemical Reactions:

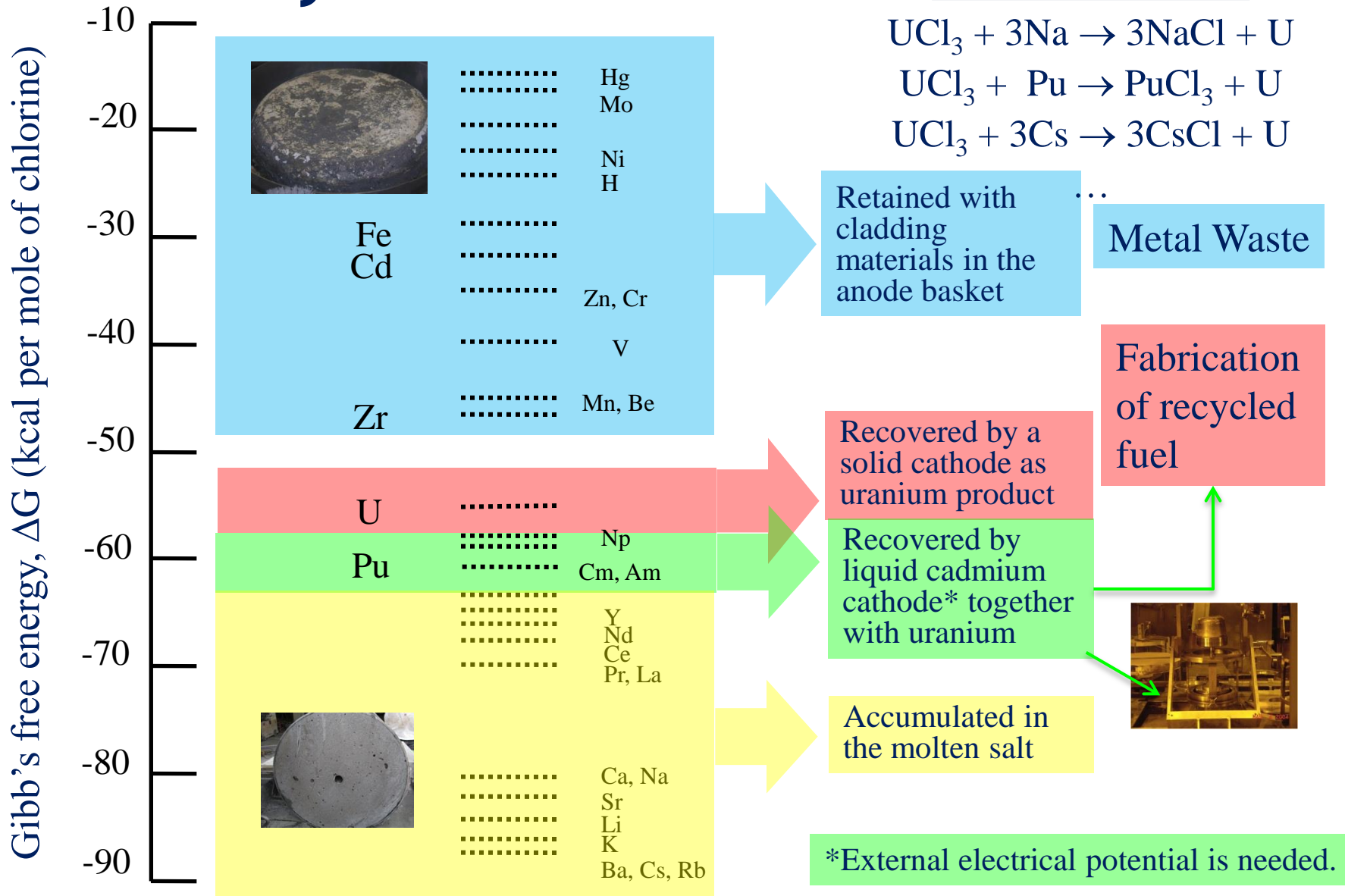

Examples of Exchange Reactions Among Used Fuel Components and LiCl-KCl-UCl₃ Salt at 500°C



This is a spontaneous chemical reaction

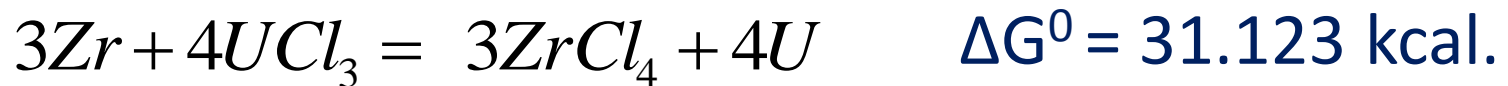

This is an non-spontaneous chemical reaction

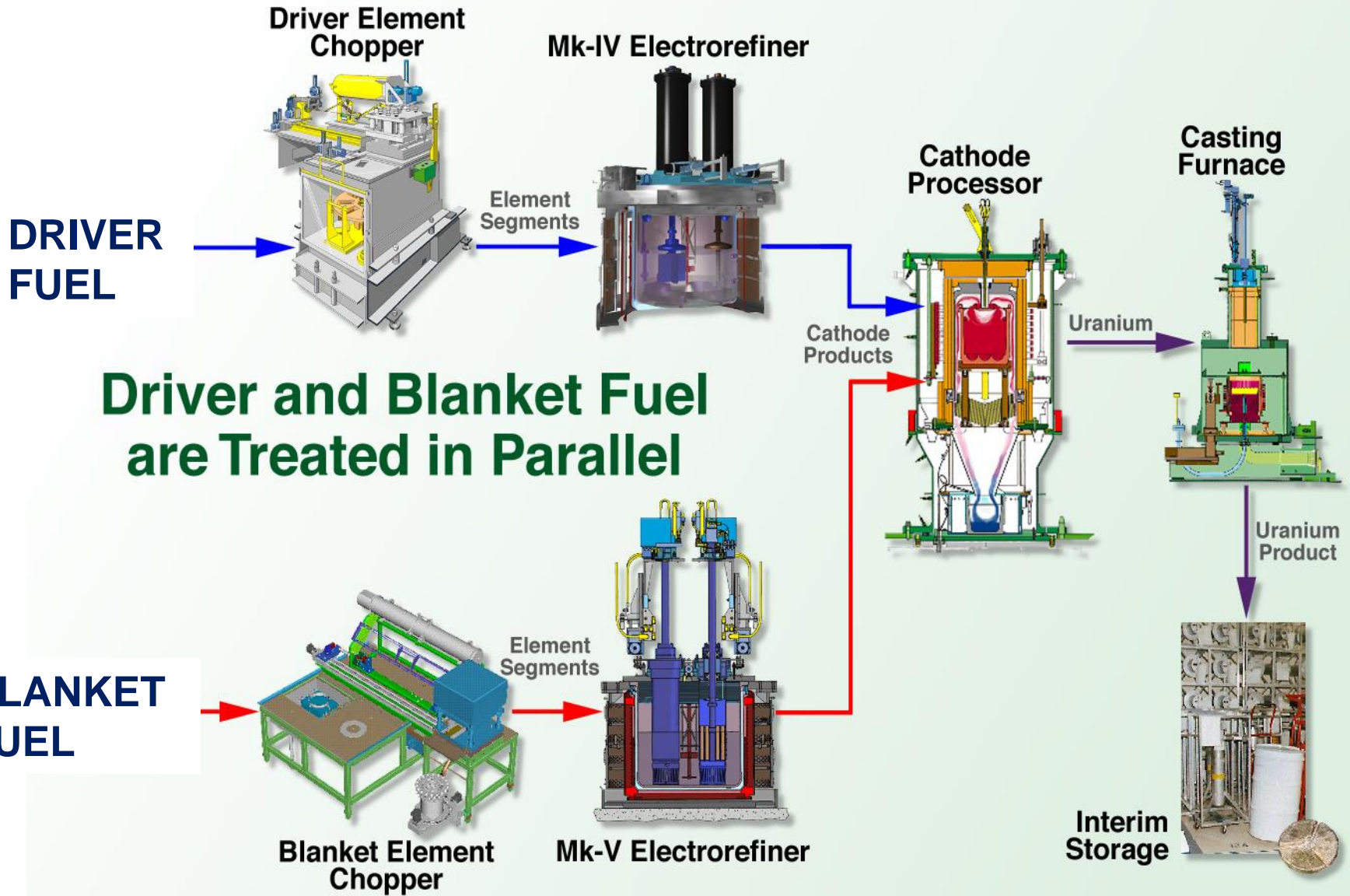

Challenge to Recover All Actinides

- Theoretically, the activity ratio of Pu to U in LiCl-KCl salt needs to be approximately 10^6 in order to produce a plutonium deposit on a solid cathode at 773 K.

Possible approach—Liquid Cadmium Cathode

- Pu and U can be co-deposited in liquid cadmium because the activity coefficient for plutonium in Cd phase is very small ($\sim 10^{-4}$)
 - The Pu to U ratio in the LiCl-KCl salt must theoretically be greater than three to co-deposit uranium and plutonium in a liquid cadmium cathode.

Liquid Cadmium Cathode

- A liquid cadmium cathode can be used to recover Pu, U, and TRU.
- It works based on thermodynamics.
- Key is reduced activity for Pu in the Cd phase

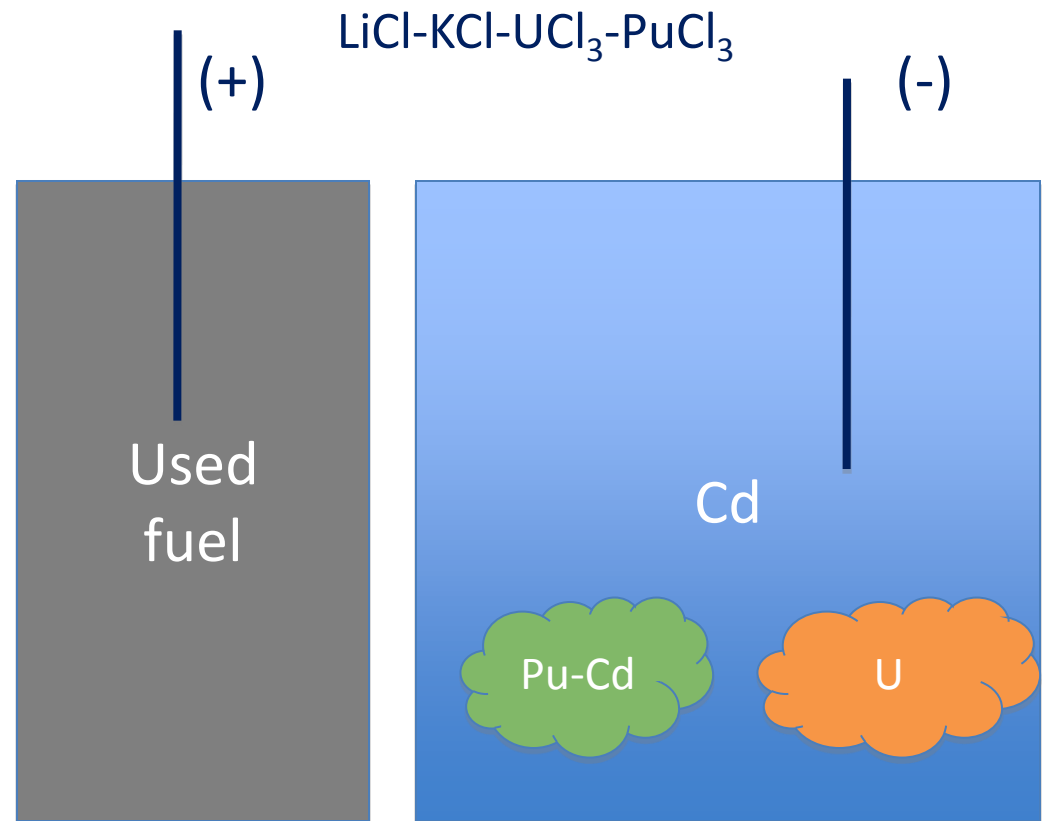

Engineering-Scale Group Actinide Recovery

- Liquid cadmium cathode tested in the Mk-V ER
- Approx 1-kg of TRU collected in each run
- Objective of engineering scale tests:
 - Demonstrate scalability of process
 - Design pounder operation to minimize dendrite formation
 - Determine optimal crucible materials and designs

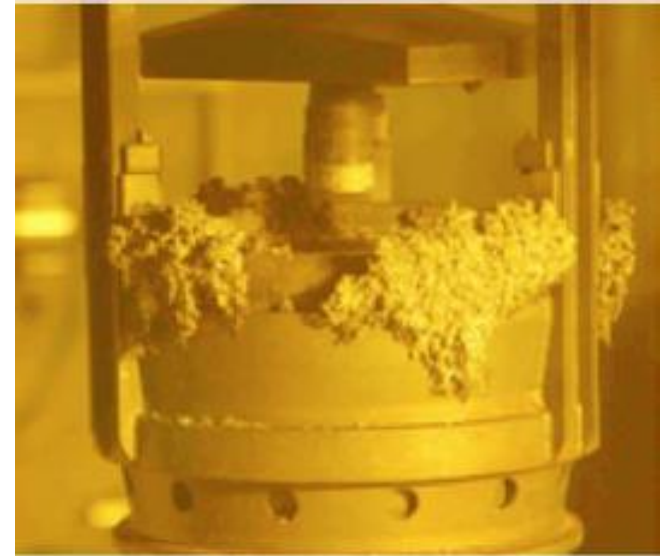

Vaden et al., *Nuclear Technology*, **162**, 124-128 (2008).

Summary

- Differences in free energy of formation between chloride salts of fuel constituents allow for easy separation of fission products and actinides.
- Standard ER operation results in dendritic, pure U deposits at a cathode.
- Engineering-scale ERs operated for 10+ years at INL (previously ANL-West) for treating used EBR-II fuel.
- Liquid cadmium cathode can be used to co-deposit U, Pu, and minor actinides.

Thermal Processing

A decorative graphic consisting of a solid green horizontal bar that spans the width of the slide. Below this bar, on the right side, there are several horizontal lines of varying lengths and colors, including shades of green and white, creating a layered, modern look.

Cathode Processor

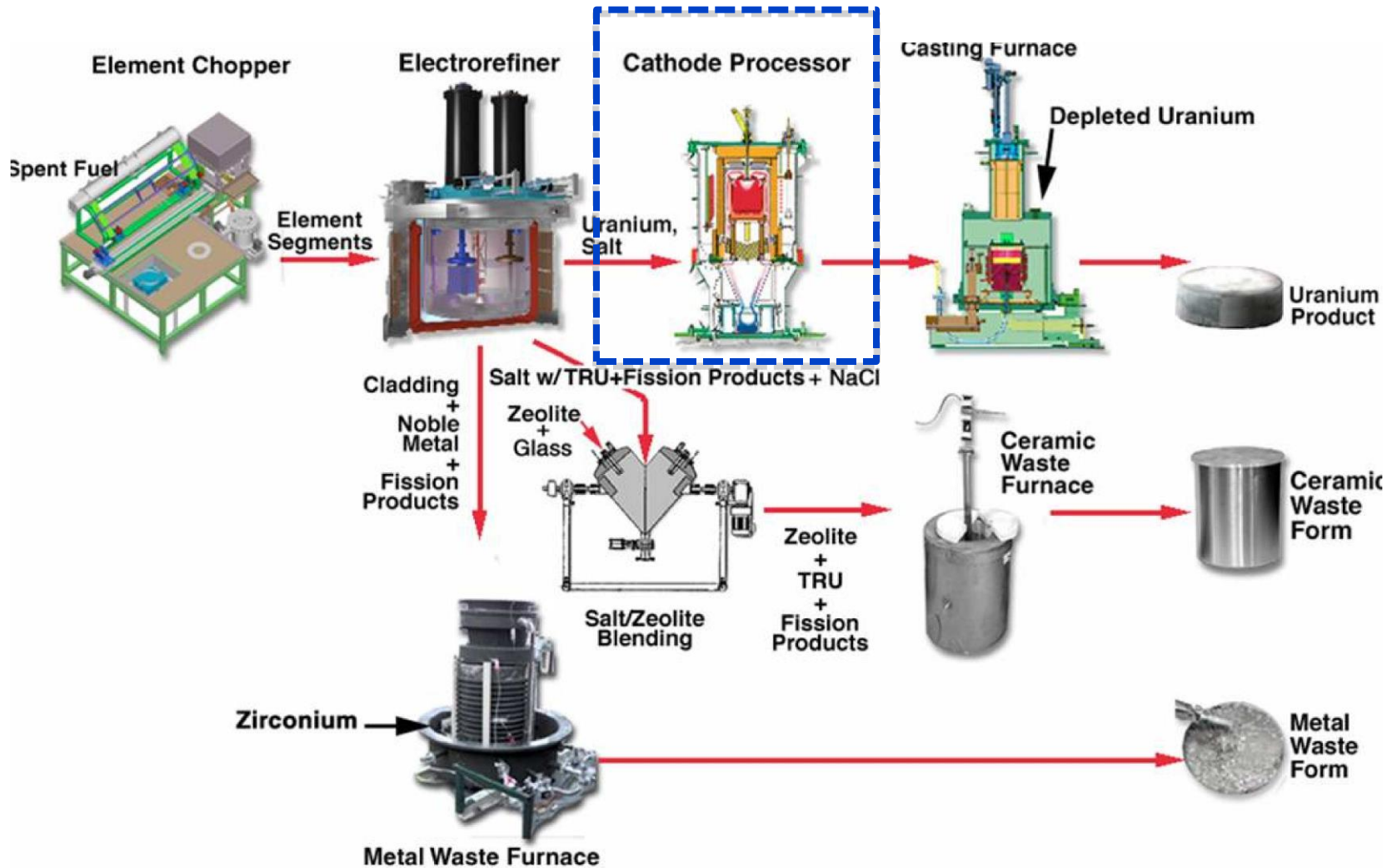

Cathode Processing

- Cathode products from electrorefining have adhering salt and cadmium that require separation from the uranium.
- Method of salt and cadmium separation during pyroprocessing is high temperature distillation.
- Distillation or retort process is called “**cathode processing**.”
- Cathode processing includes initial consolidation of uranium.

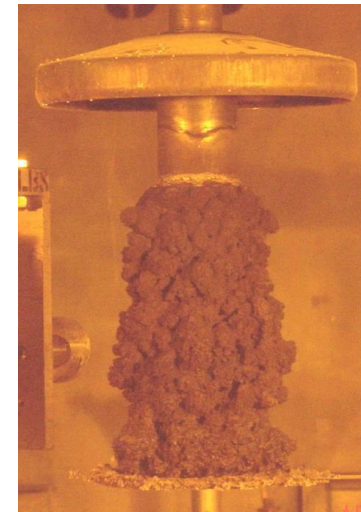

Distillation Background

- Clausius-Clapeyron Equation: $\ln \frac{P_2}{P_1} = \frac{\Delta H_{vap}}{R} \left(\frac{1}{T_1} - \frac{1}{T_2} \right)$

where P_2 is the cathode processor operating pressure

P_1 is the vapor pressure at T_1 (equals 760 Torr)

ΔH_{vap} is the heat of vaporization

R is the universal gas constant

T_1 is the boiling point

T_2 is the boiling point due to vacuum P_2

Cathode Processor Pressure (Torr)	LiCl Boiling Point (deg C)	LiCl-KCl Boiling Point (deg C)	Cd Boiling Point (deg C)
760	1382	1422	765
10	913	944	482
1	757	786	386
0.1	638	664	312

Cathode Processor Products

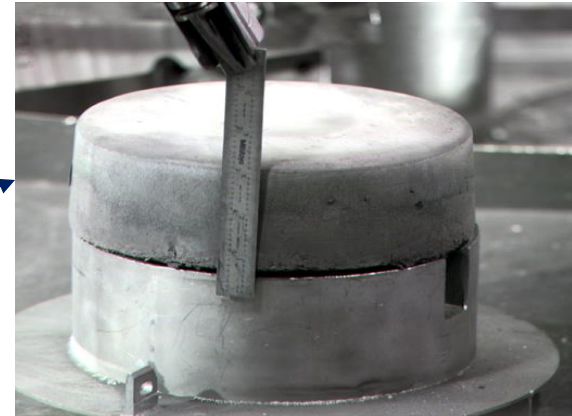
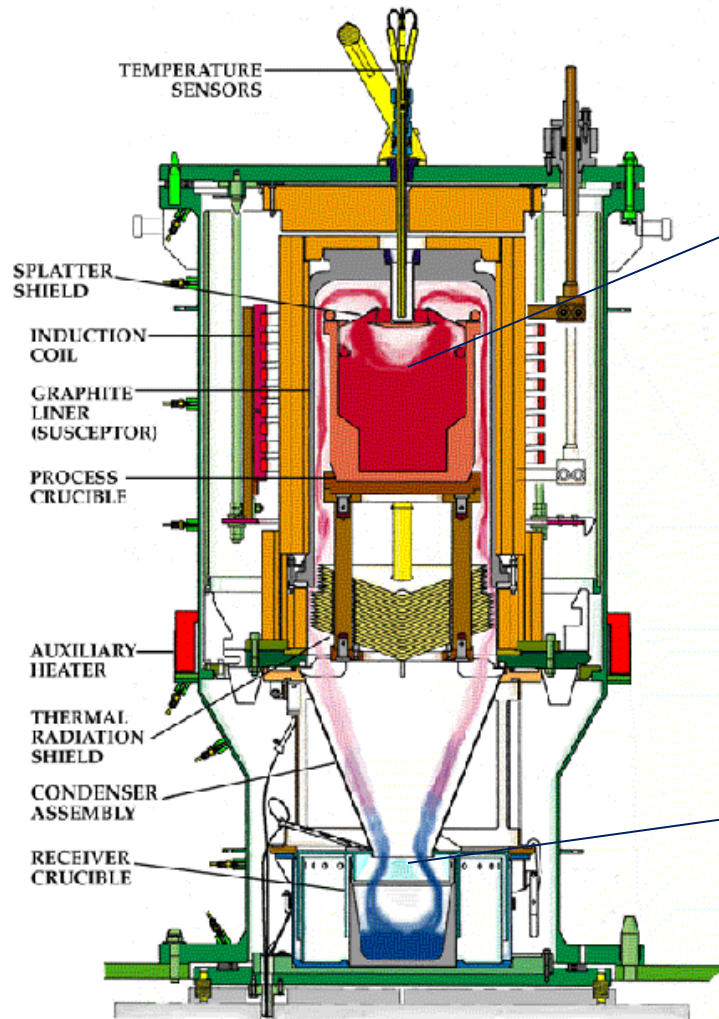

Uranium

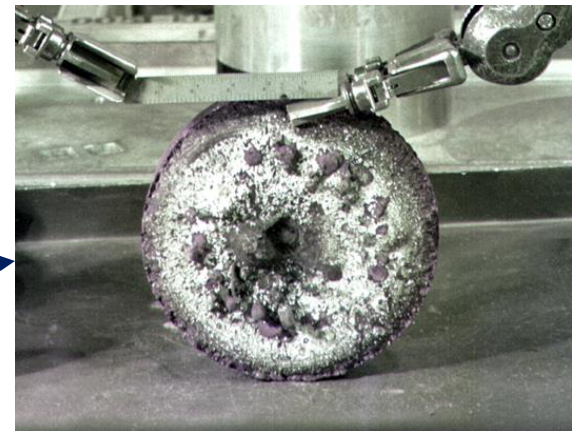

Salt

Cathode Processor Characteristics

- Electrorefiner Products:
 - ~80% Metal and ~20% Salt (except ~1% Cd for Driver)
 - ~20 kg Charge for Driver
 - ~55 kg Charge for Blanket
- Bottom Loading of Crucible Assembly
- Induction Coil: 25 kW Power Supply with Passive Cooling
- Vacuum Capability of ~100 mTorr
- Coated Graphite Crucibles (~15 liter Capacity)

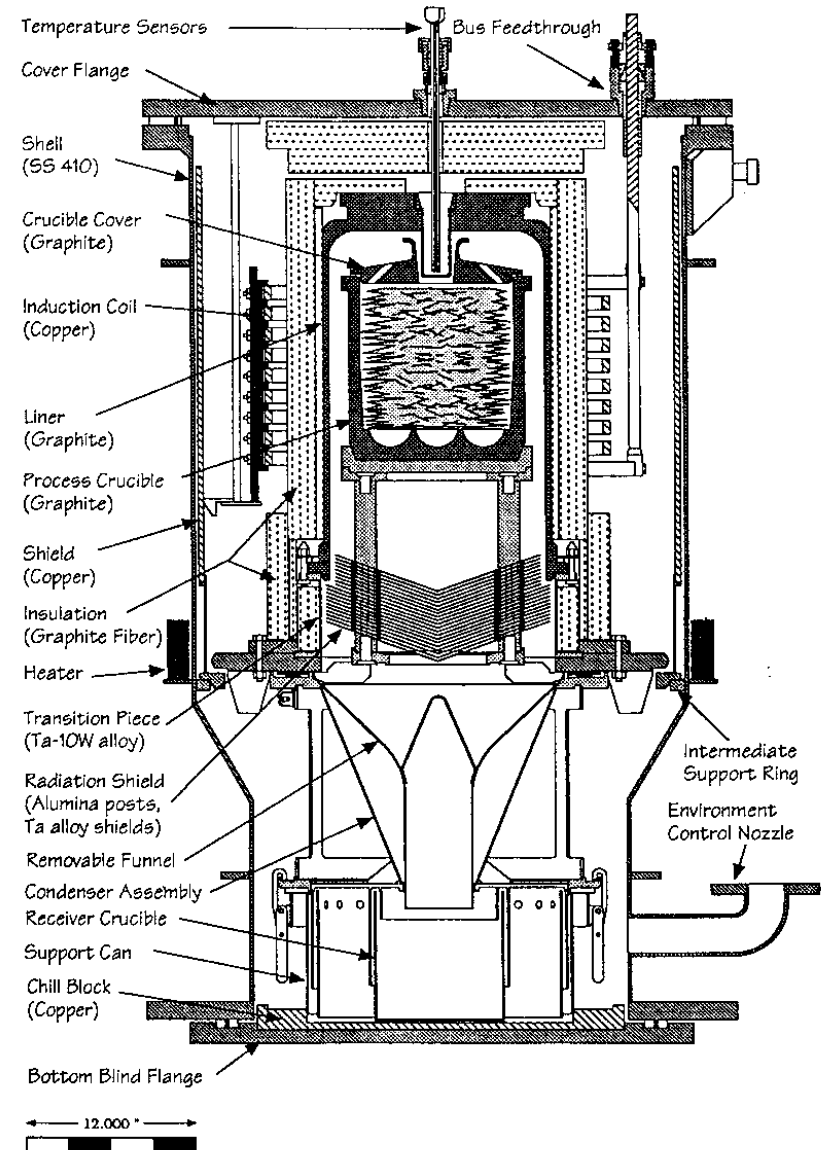

Cathode Processor Crucible

- Challenge
 - To Find a Material/Coating Compatible with Reactive Chloride Salts, Molten Uranium, and Harsh Thermal Environment (up to 1300°C)
- Initial Testing Showed ZrO_2 Coating on Graphite to be the Best Performer
 - Other Materials/Coatings Tested Include Y_2O_3 , CaO, ThO_2 , Er_2O_3 , MgO, HfO_2 , Al_2O_3 , BeO, Plasma-Sprayed W-Re and Mo-Re, W, Nb-30Ti-20W, AlN, TiN, ZrB_2 , and TiC

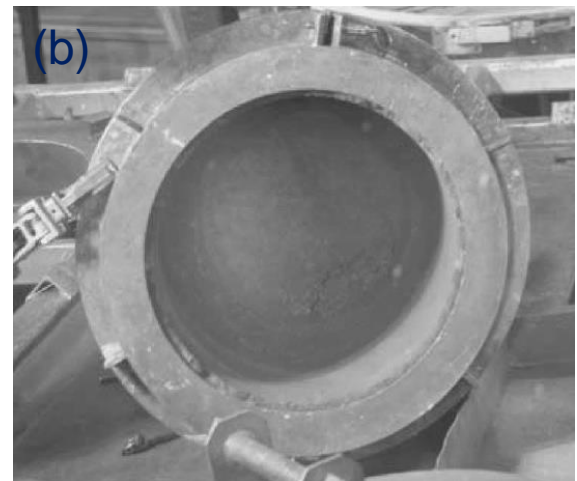
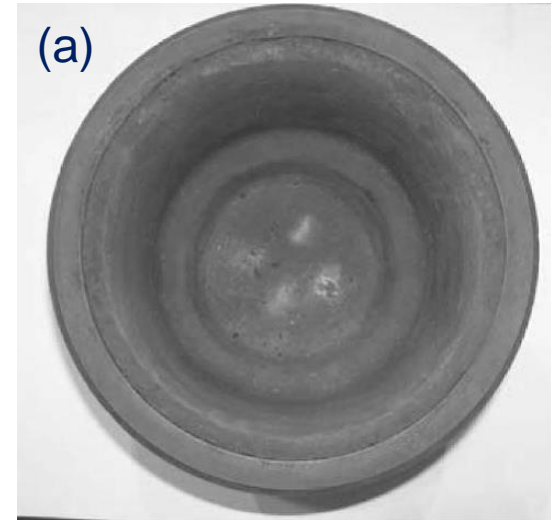

(a) Zirconia-Based Castable Crucible Prior to (b) and After the FCF Cathode Processor Test

Cathode Processor Crucible (cont.)

- ZrO_2 on Graphite
 - Advantages
 - Compatible with Chloride Salt and Uranium
 - Graphite Suscepts and is Durable
 - Easily Applied
 - Disadvantages
 - Cleaning and Recoating
 - Dross Formation Resulting in 2-3 wt. % U Loss ($ZrO_2 + U \Rightarrow UO_2 + Zr$)
- Under Development
 - HfN Coating on Metal Substrate
 - Castable Materials

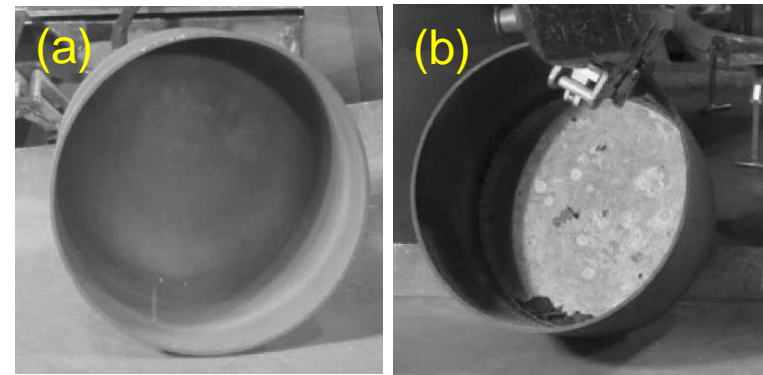
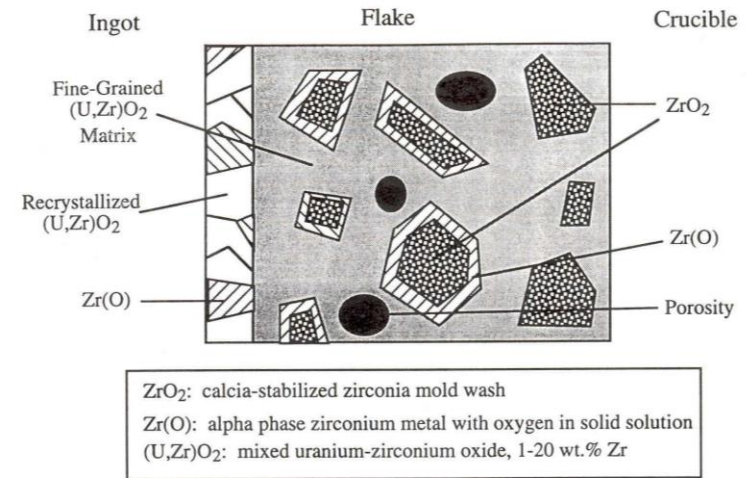

(a) Hafnium nitride coated crucible prior to (b) after the first FCF cathode processor test.

Cathode Processor Crucible Development

- HfN-coated Nb crucible:
 - Several tests with irradiated products have shown minimal signs of reaction.
 - Tests will continue with irradiated products to confirm compatibility.
 - Pursuing scale-up to >15 liter.
- Zirconia castable with graphite:
 - Tests with irradiated products have been performed at both mid-scale (9 liter) and full-scale (15 liter).
 - Pro: Elimination of crucible cleaning.
 - Con: Slight uranium loss due to reaction.

Cadmium Distillation



Actinide metal product

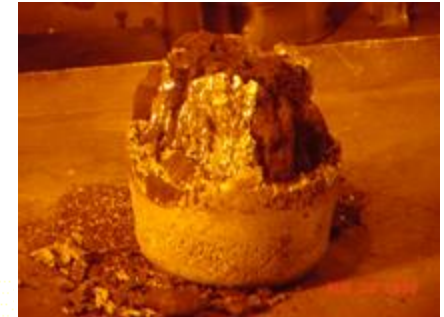
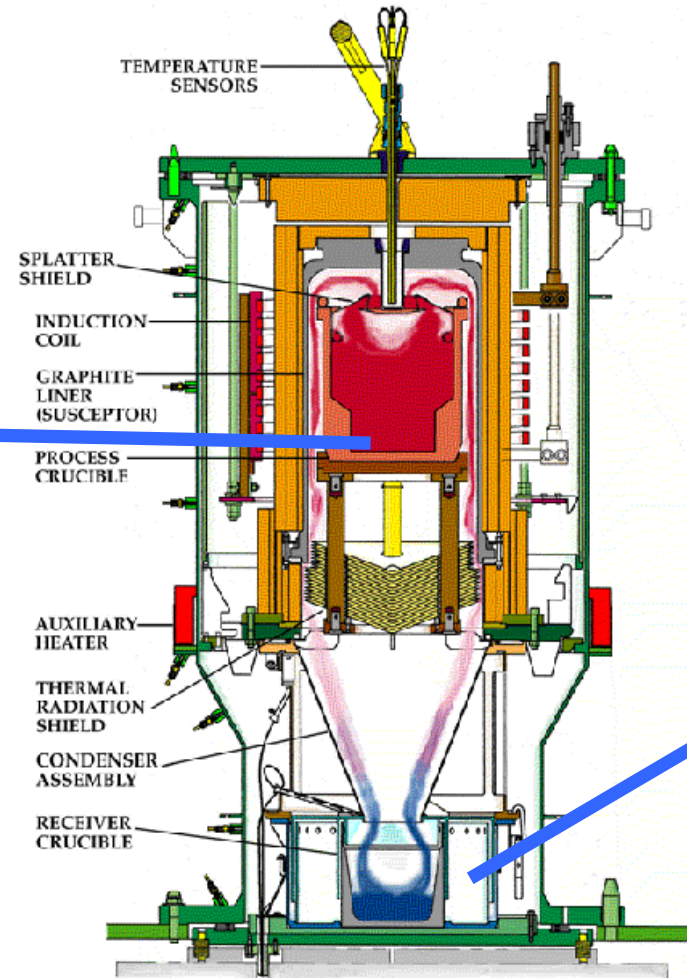

Distilled Cd + salt

Casting Furnace

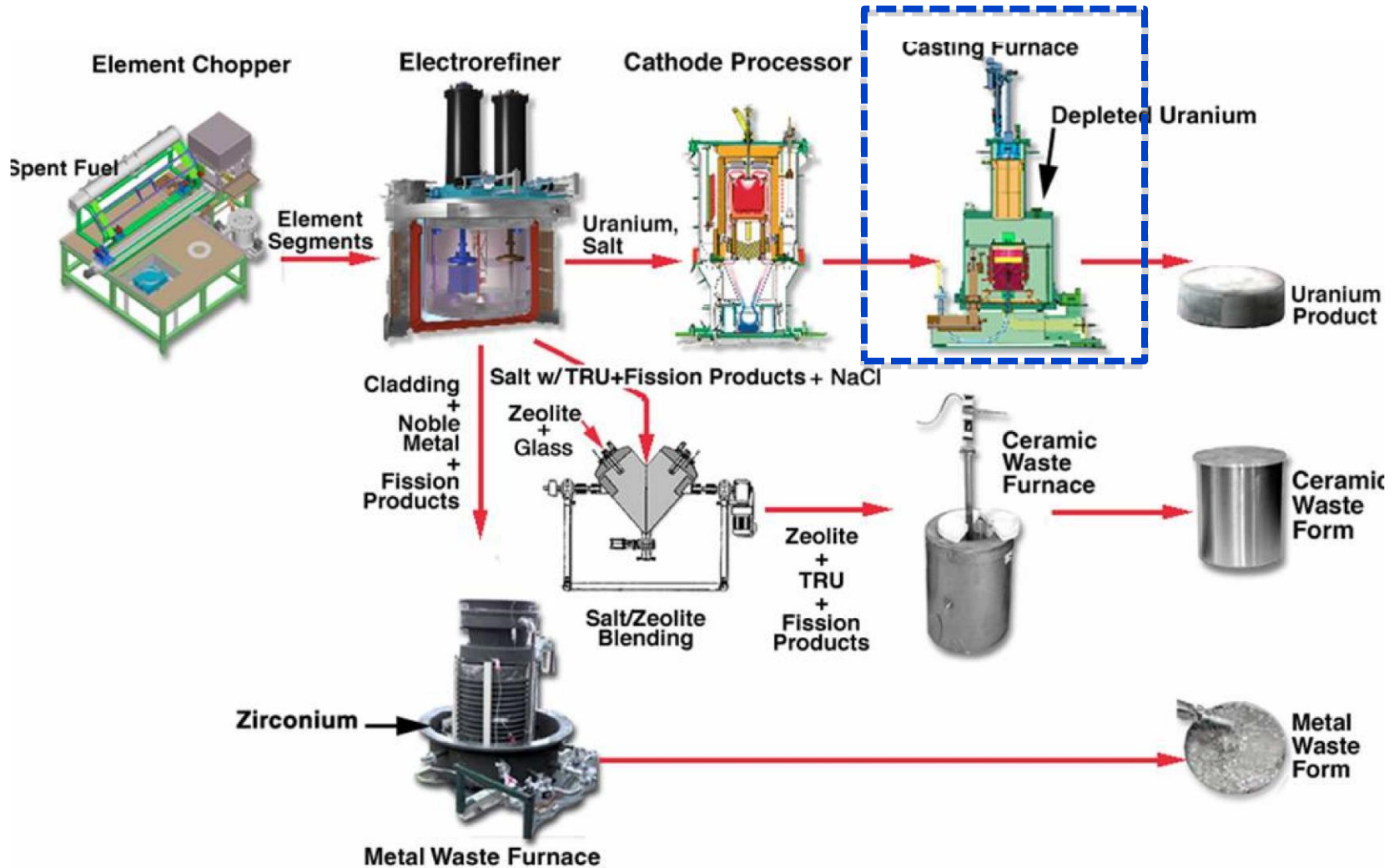

Casting Furnace

- Originally used for casting fuel, now used for downblending HEU and sampling product
- Design based on early EBR-II (1960's) and FMF (1980's) Fuel Fabrication Experiences
- Batch Size: 12-54 kg Uranium
- Casting/Sampling Sequence:
 - Fuel is melted and stirred in Y_2O_3 coated graphite crucible
 - Furnace is evacuated and ZrO_2 coated SiO_2 molds are submerged
 - Pulse pressurization of vessel rapidly injects/freezes fuel in molds
 - Molds are removed and shattered to release fuel slugs
 - Slugs are sectioned for samples

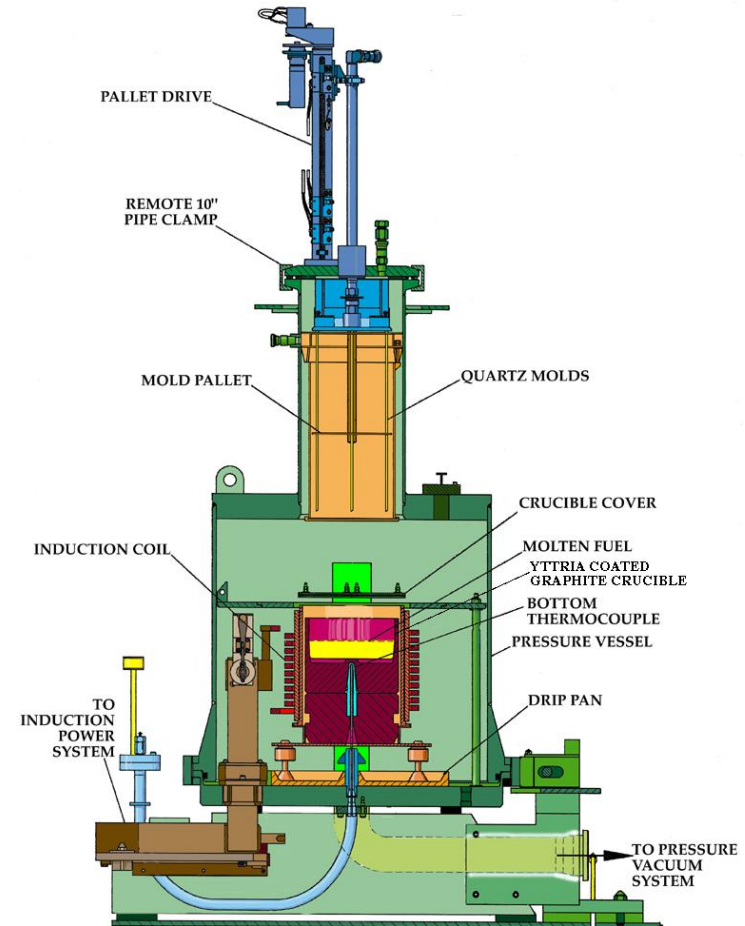

Metal Waste Furnace

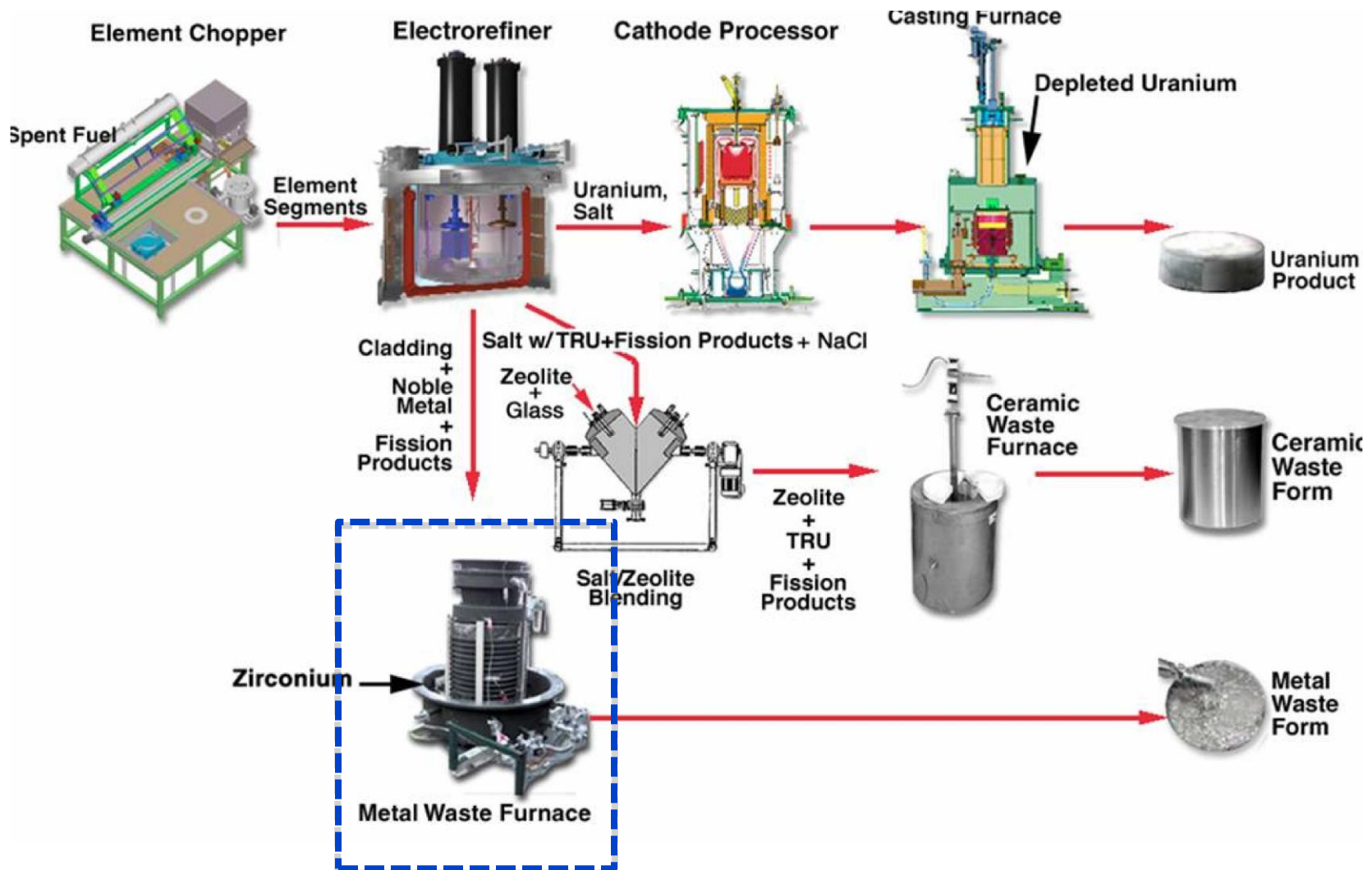

Metal Waste Form

- Composed primarily of stainless steel and zirconium
- Can successfully contain noble metal fission products and up to 10 wt% actinides
- Much more corrosion resistant than borosilicate glass

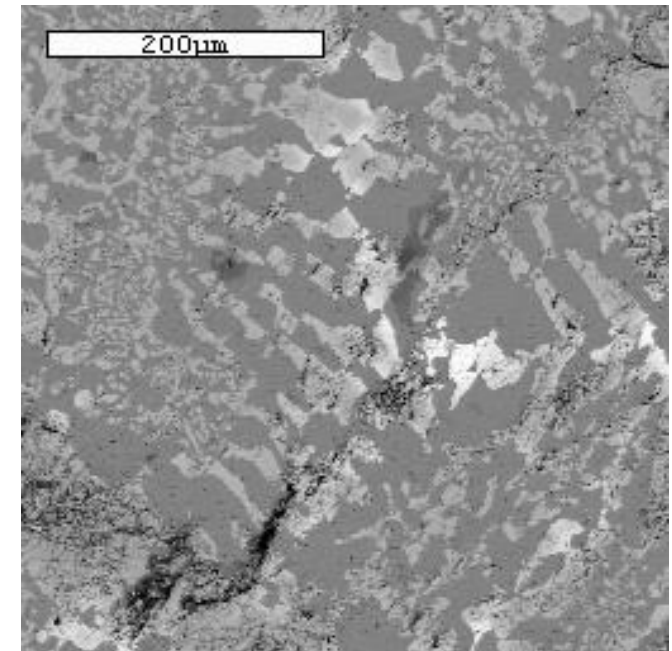

Constituents of the Metal Waste

- Cladding hulls and plenum sections
- Residual Zr (driver fuel)
- Residual metallic sodium (from plenum)
- Noble metal fission products
- Undissolved actinides (typically less than 3%)

Functionality of the Metal Waste Furnace

- Metallic sodium in the cladding plenum sections is reacted with ferrous chloride to form stable sodium chloride and metallic iron.
- Salts (primarily LiCl, KCl, and NaCl) are vacuum distilled from the cladding hulls between 800-1350°C.
- Hulls and zirconium wire are melted and alloyed for approximately three hours at 1600°C to form a homogeneous alloy.



Why Add Zr Wire?

- Eutectic point results in low melting point (1300°C).
- Maximum sustained operating temperature of the furnace is 1600°C).

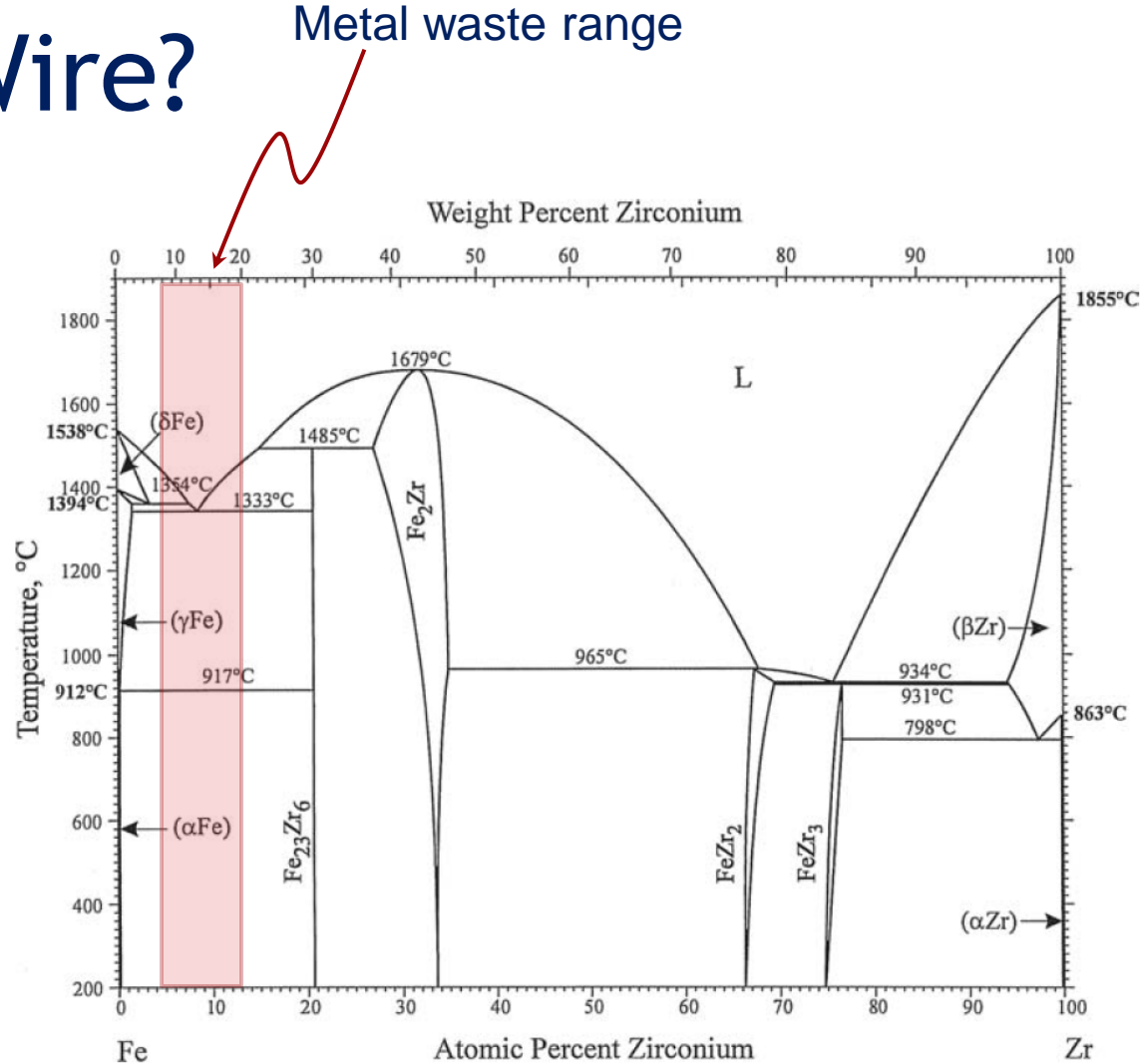

Stein et al. (2002), J. Phase Equilibria, **23**(6), 480-494.

Metal Processing Summary

- Cathode processor removes salt and/or cadmium from actinide deposits formed at ER cathode.
- Casting furnace used for multiple purposes:
 - Product sampling;
 - Downblending HEU; and
 - Fuel fabrication.
- Metal waste furnace removes salt from cladding hulls and forms melts Zr-rich alloy that becomes a high level waste (contains noble metal fission products).

Ceramic Waste Processing



Ceramic Waste Process

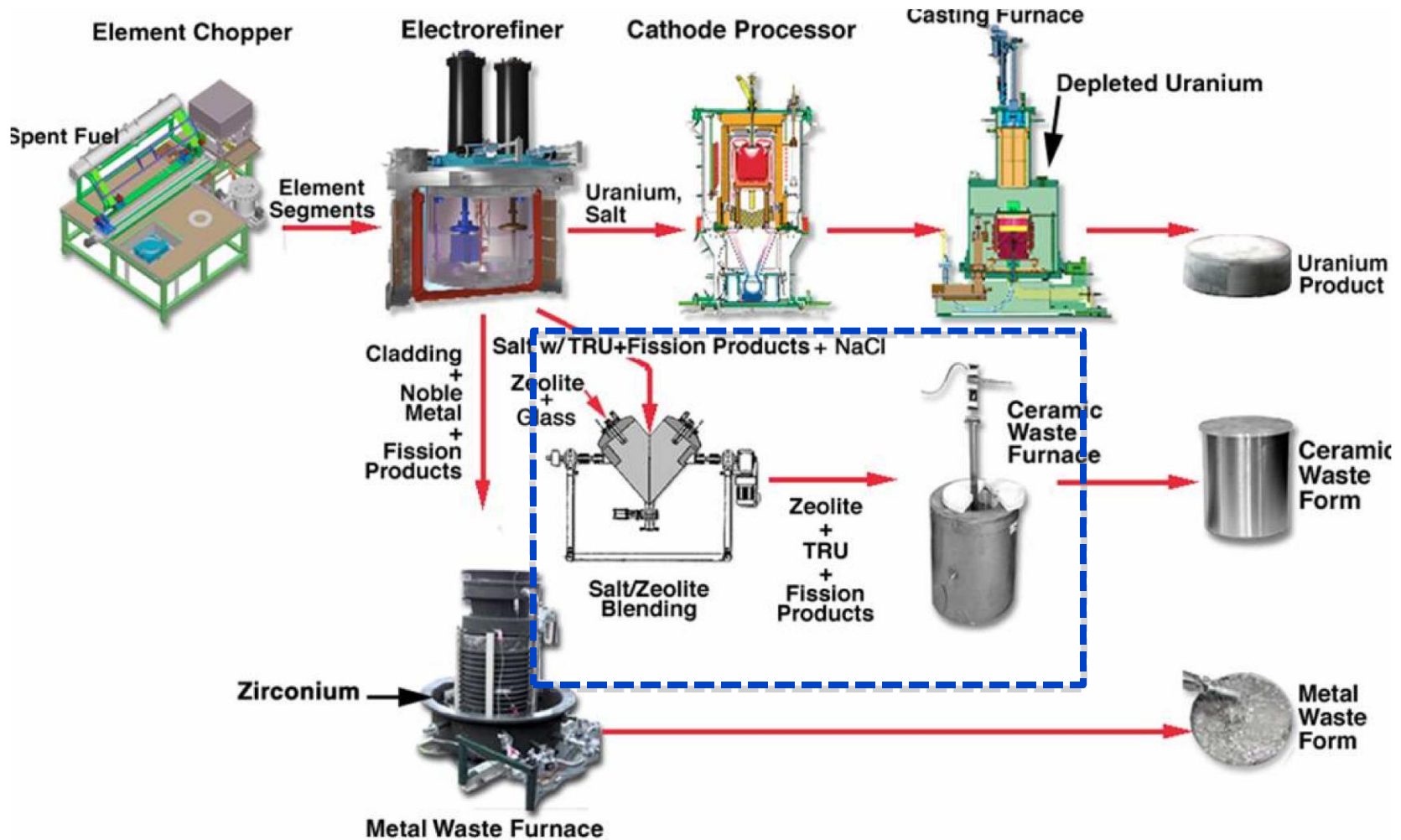

Electrorefiner Salt Contamination

- Contaminants accumulate in the electrorefiner:

Fission products
(CsCl, SrCl₂, CeCl₃...)

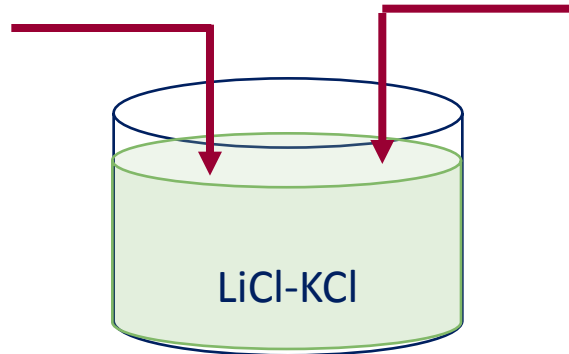

NaCl (sodium bonded fuel)

- What dictates the usable life of the salt?
 - NaCl concentration in the case of sodium-bonded fuel (melting point)
 - Fission product chloride concentration in the case of other fuel (decay heat)
 - Plutonium concentration in the case of Pu-rich used fuel

Chemistry of Waste Salt Processing

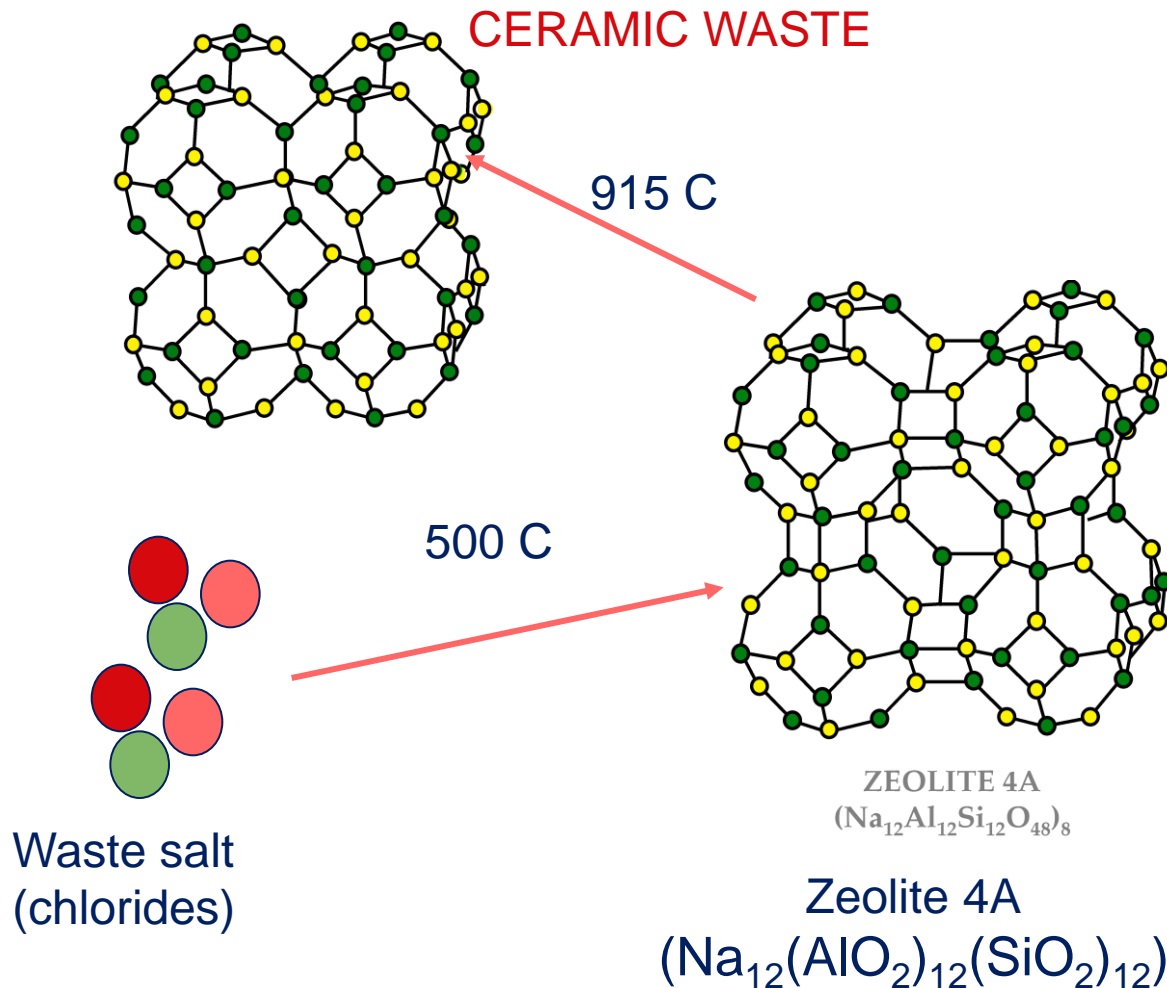

- Zeolite is a crystalline aluminosilicate material containing micropores
- Zeolite 4A absorbs salt at 500 °C.
- Salt occluded zeolite-A is then mixed with glass and heated to form sodalite.
- Most salt is bound by sodalite, while some partitions into the glass phase.

Salt Occlusion in Zeolite-A

- This is known as the “throw-away process,” since it involves discarding all of the salt, including the useful LiCl and KCl
- Approximately 10 wt% salt is accommodated in the zeolite-A structure
- Since fission product concentration will not exceed 30 wt% in the salt, this means that only 3 wt% fission product loading possible in this waste form.
- This is good motivation for developing an advanced, selective process.

“Throw Away” Ceramic Waste Process

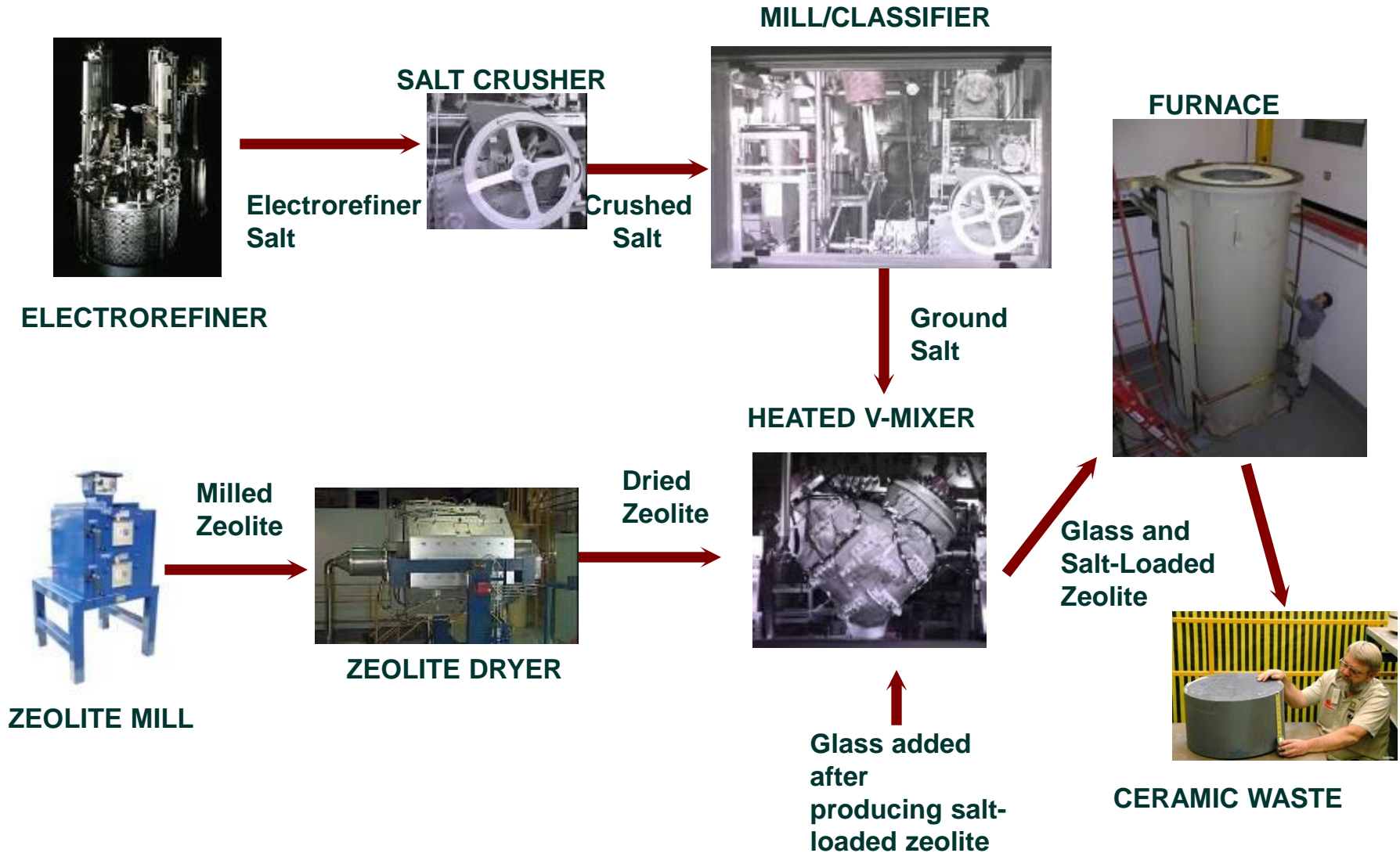

Zeolite Drying

- Zeolite-4A can hold up to ~20 wt% water in equilibrium with ambient air.
- Target of 0.2 wt% water in zeolite prior to use in ceramic waste process:
 - Minimize corrosion due to salt-water-metal interactions
 - Maximize capacity for zeolite to hold salt
 - Minimize pores in ceramic waste form
- Nominal drying method
 - Heat to 550°C
 - Apply vacuum
 - Keep zeolite fluidized
- Zeolite sample testing:
 - Moisture (Karl-Fischer Titration, Near Infrared Absorption)
 - Rehydration capacity

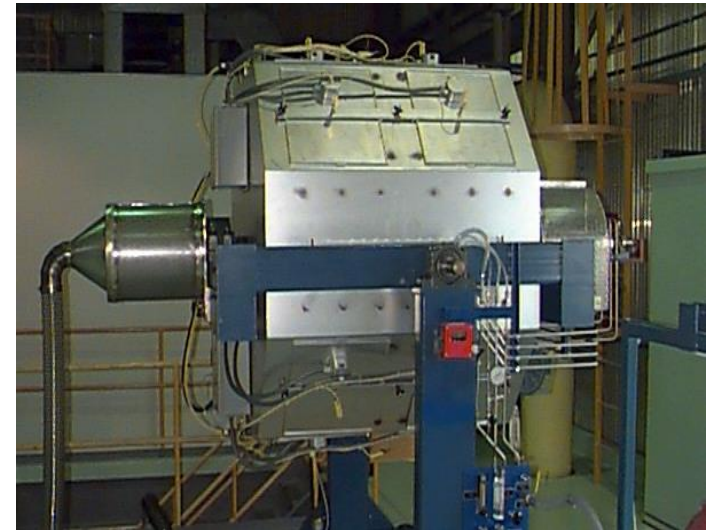

Salt Solidification and Milling

- Contaminated salt is removed from ER and solidified into cubes.
- These cubes are transferred from Fuel Conditioning Facility (FCF) to Hot Fuels Examination Facility (HFEF)
- ER Salt crushed to < 1.0 cm in size.
- Salt particulate is then ground in high speed mill/classifier to 45-250 μm .

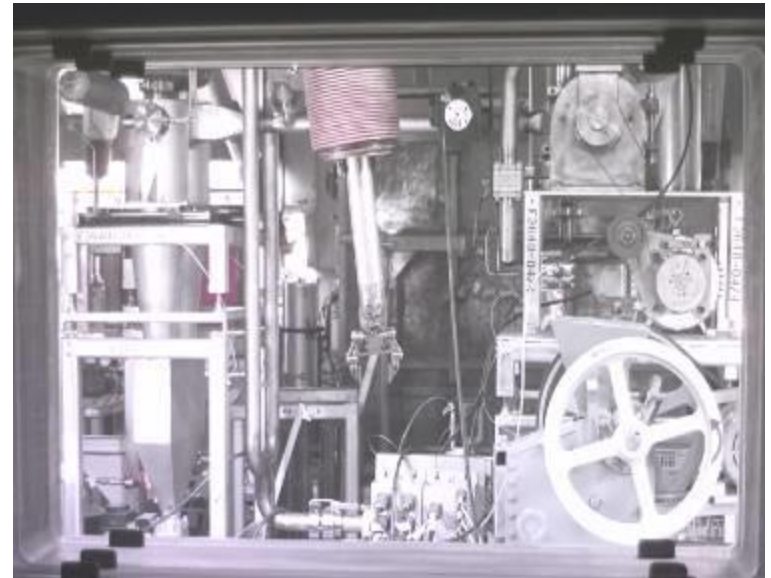

Salt/Zeolite Blending

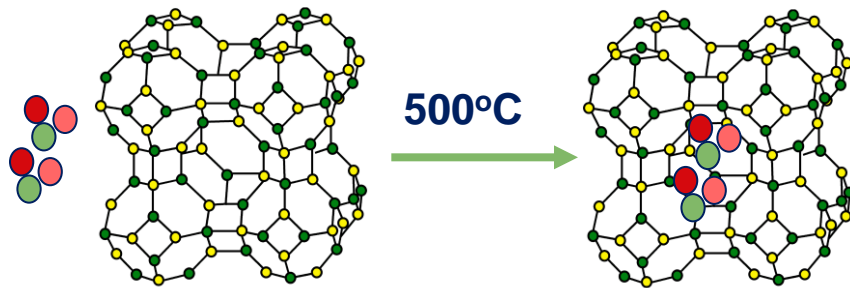

- Custom engineered v-blender capable of:
 - $T > 500^{\circ}\text{C}$
 - Heat up time $\approx 4\text{-}5$ hours
 - Rotation at ≈ 20 rpm
 - 120 kg batch limit

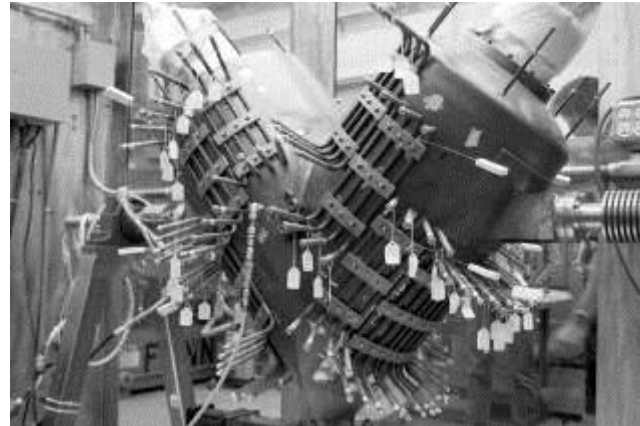

V-blender before installation of insulation

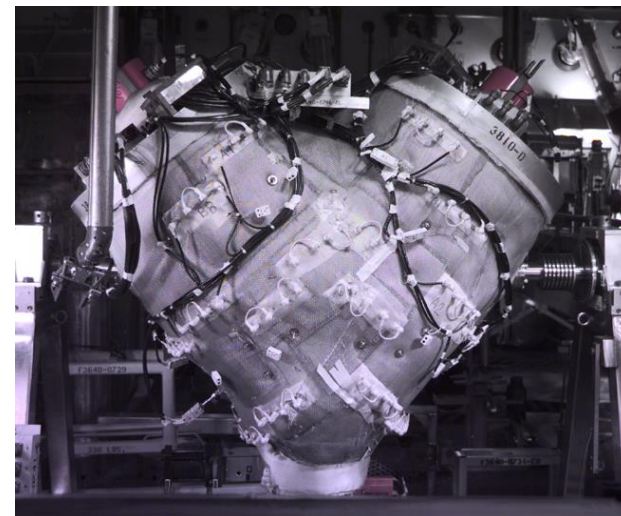

V-blender in hot cell

Pressureless Consolidation

- After blending salt-loaded zeolite with glass, conversion to monolithic sodalite waste form is the final step.
- Pressureless consolidation method replaced Hot Isostatic Press after the 1999 technology demonstration for DOE.
- Furnace for out-of-cell, full-scale testing installed in 2005.
 - Maximum operating temperature of 1025 °C
 - Sealed with atmosphere control
 - Capable of processing waste forms 320-400 kg

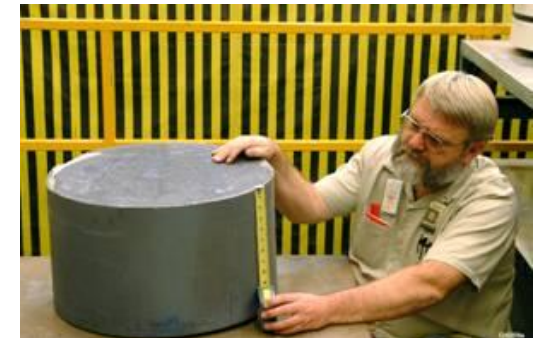
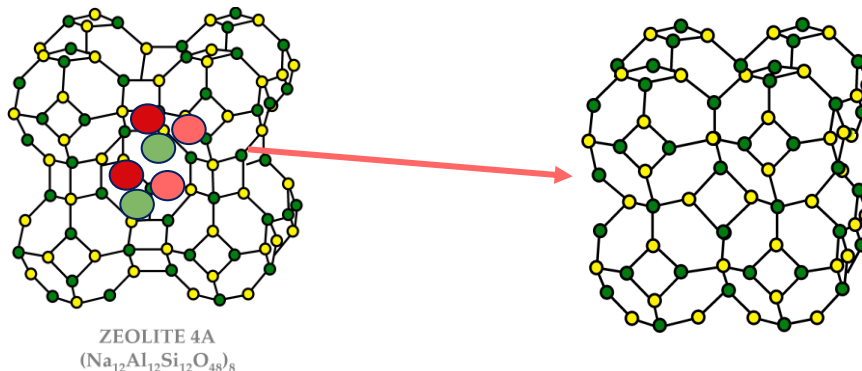

High Level Waste Disposal

High Level Waste Shipment
Coordinated with INEEL
Spent Nuclear Fuel

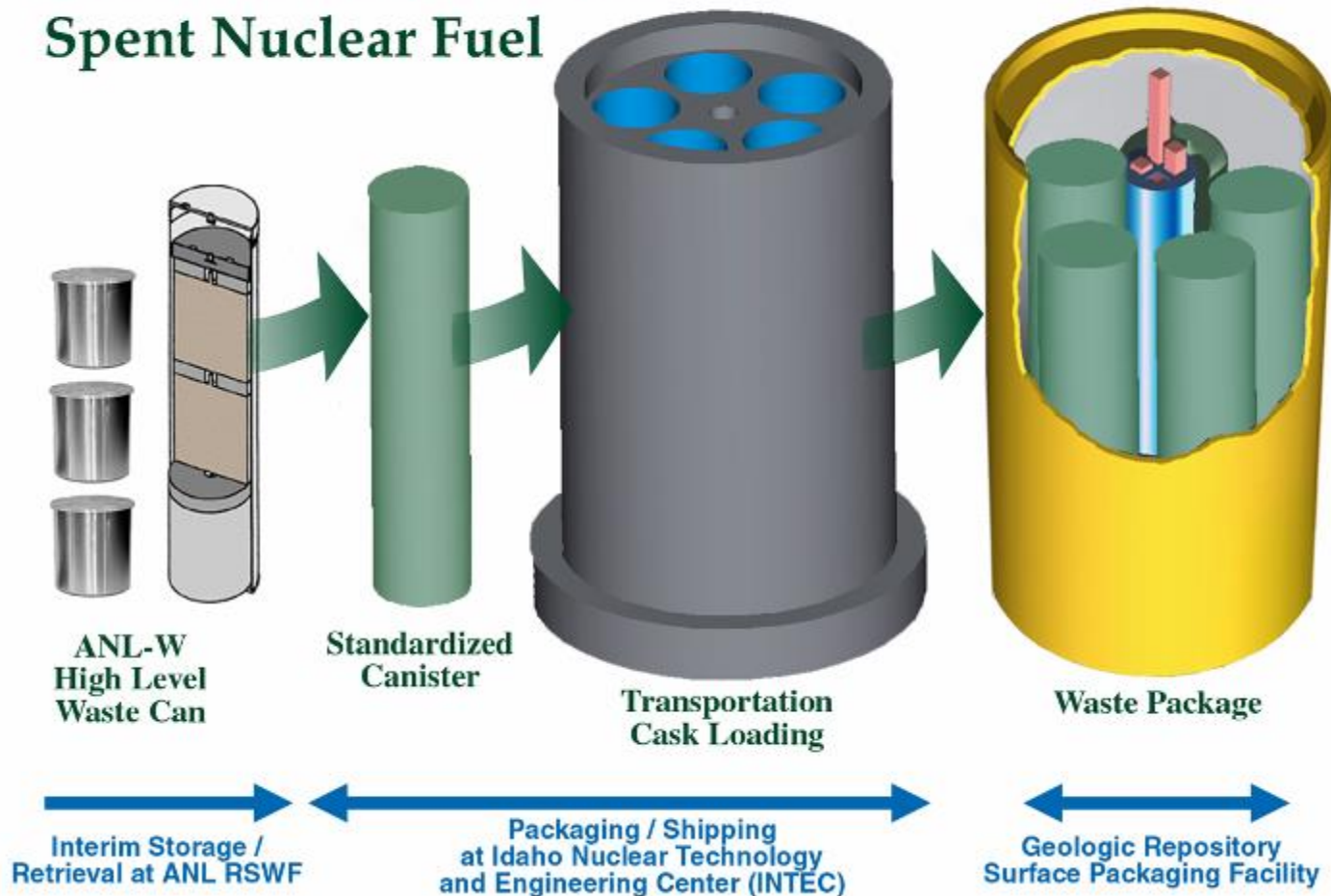

Ceramic Waste Summary

- Active metal fission products from used metal fuel accumulate in the electrorefiner salt and need to be periodically disposed
- Ceramic waste process developed for EBR-II used fuel treatment handles the salt disposal
- Ceramic waste form is glass-bonded, salt-loaded sodalite
- *Drawdown and ion exchange are advanced technologies that can improve the ceramic waste process by minimizing repository impact*
- *Ion exchange model has been developed and verified benefits of this selective technology*

Current Direction



Success in sustainability

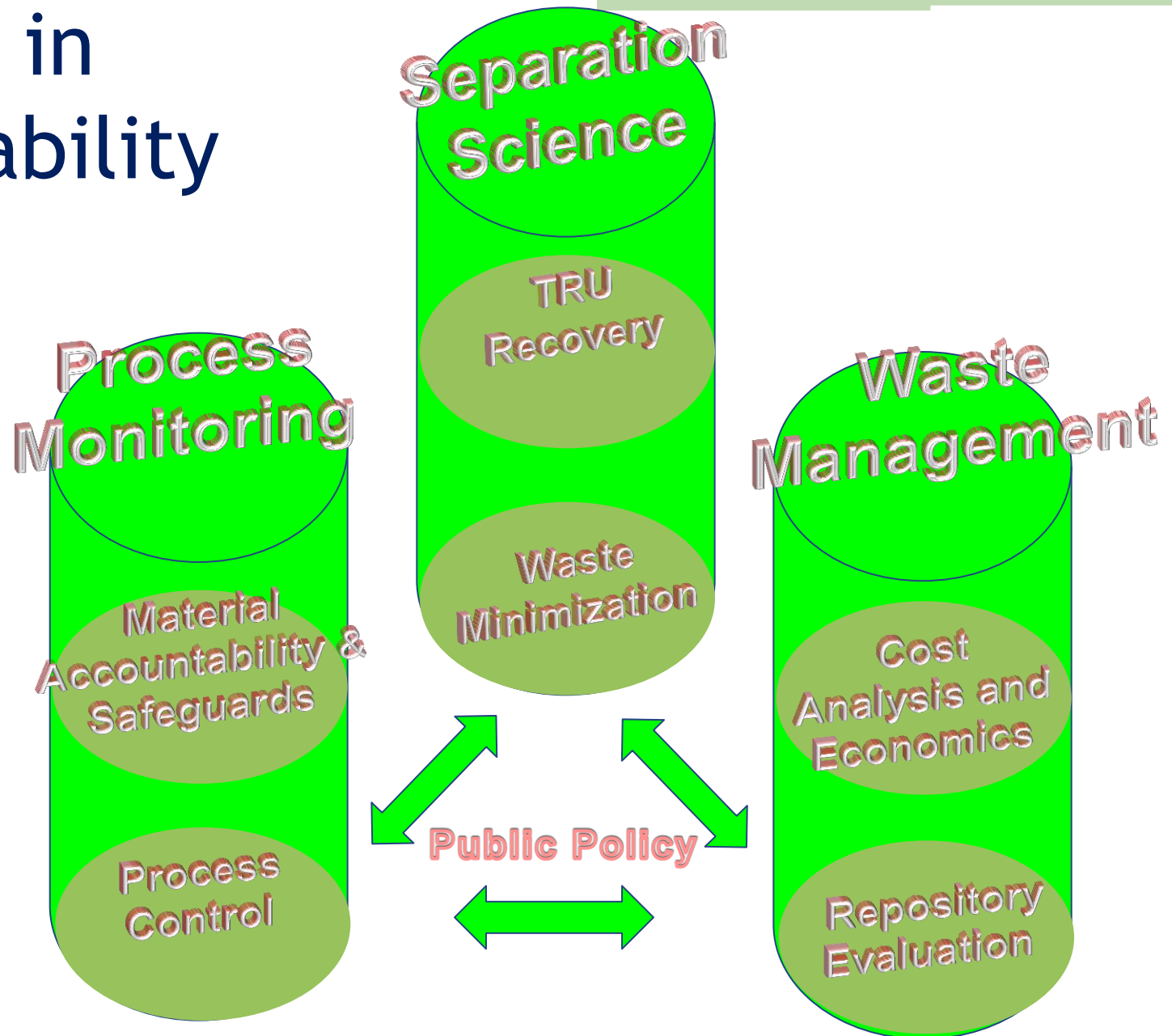

National Labs - strengths

- Strong practical processing knowledge and capabilities to handle highly radioactive nuclear materials.
- Access to samples of used fuel and other nuclear waste (salts, metals, oxides).
- Facilities to test processes from bench scale to engineering scale, including both surrogate materials and actual used fuel and waste samples.
- Extensive experience with waste form process development and understanding of regulatory issues related to waste disposal.
- Experts in nuclear non-proliferation and safeguards with strong ties to NNSA and IAEA.

Universities currently with substantial activities in electrochemical processing

Department of Metallurgical Engineering

University of Utah (UU):
Associate Professor
Michael Simpson



Department of Nuclear Engineering & also affiliate faculty Materials Science and Engineering

University of Wisconsin-Madison (UW):
Distinguished Research Professor
Kumar Sridharan



Department of Mechanical and Aerospace Engineering

The Ohio State University (OSU):
Associate Professor
Jinsuo Zhang



University of New Mexico (UNM):
Assistant Professor
Edward Blandford

Department of Nuclear Engineering



Virginia Commonwealth University (VCU):
Associate Professor
Supathorn Phongikaroon

Department of Mechanical and Nuclear Engineering

University of Tennessee-Knoxville (UTK):
Assistant Professor
Steven Skutnik



Department of Nuclear Engineering

REPORTED RESEARCH ACTIVITIES IN THE USA

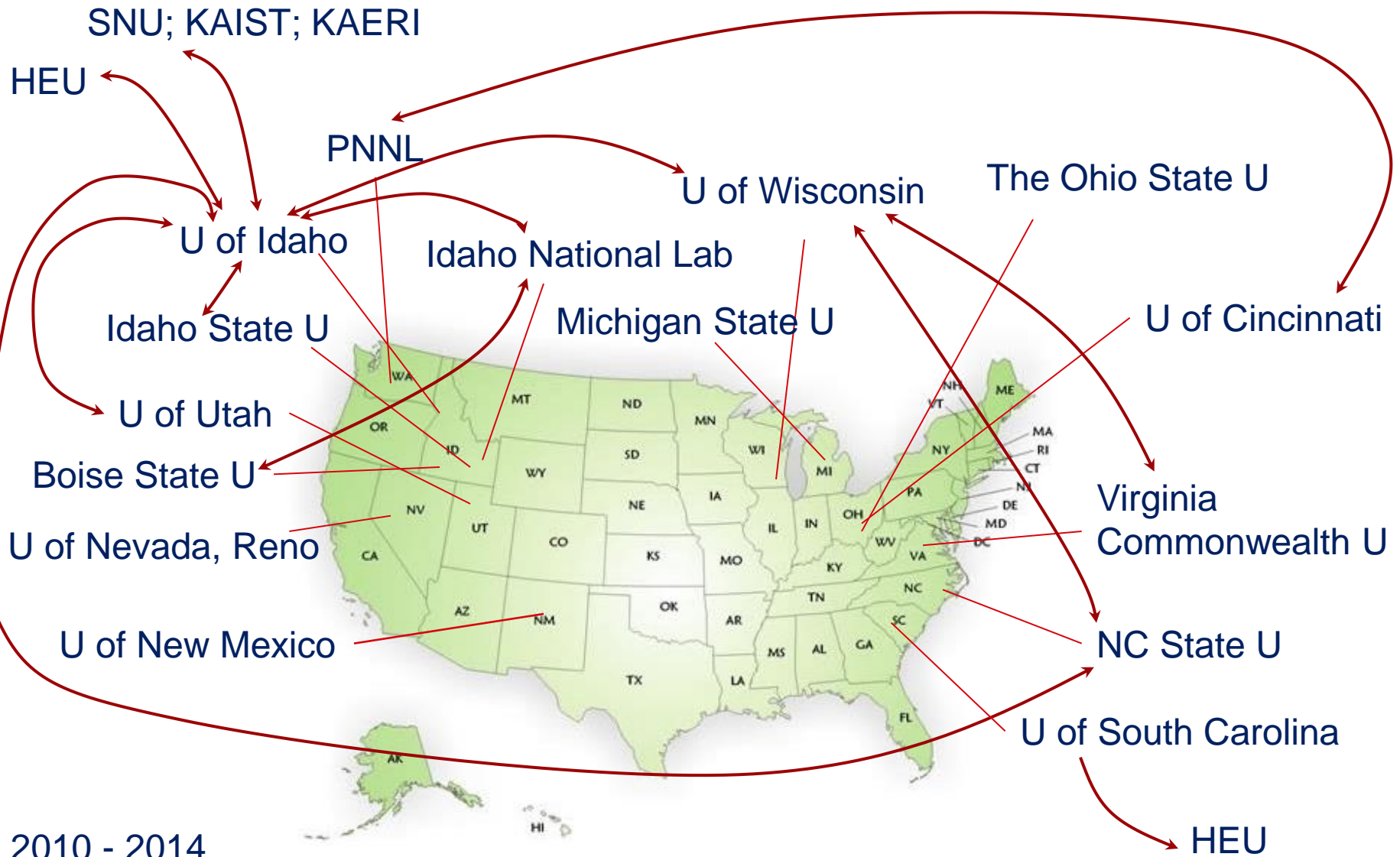

2010 - 2014

REPORTED RESEARCH ACTIVITIES IN CHINA



2010 - 2014

REPORTED RESEARCH ACTIVITIES IN JAPAN

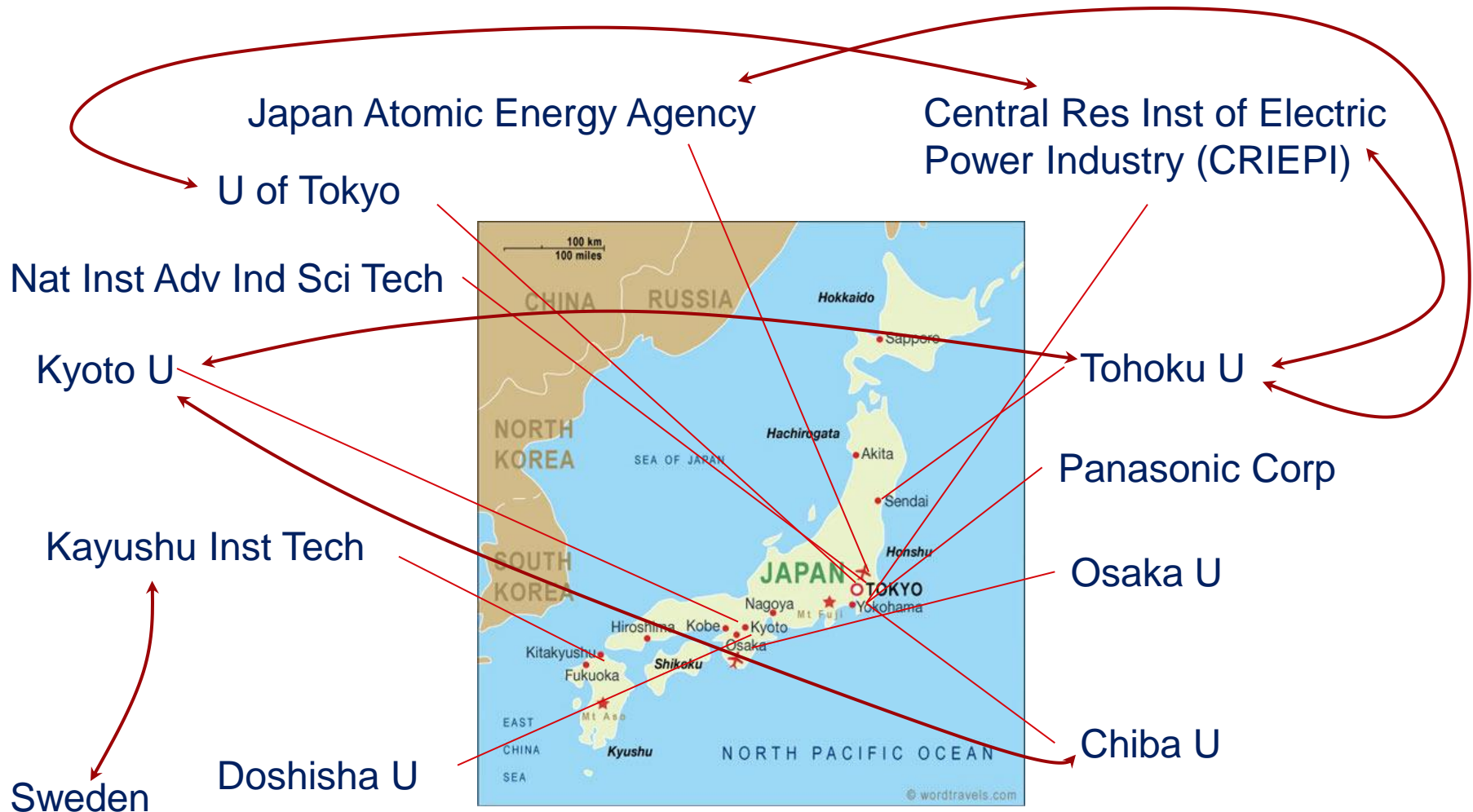

REPORTED RESEARCH ACTIVITIES IN EUROPE

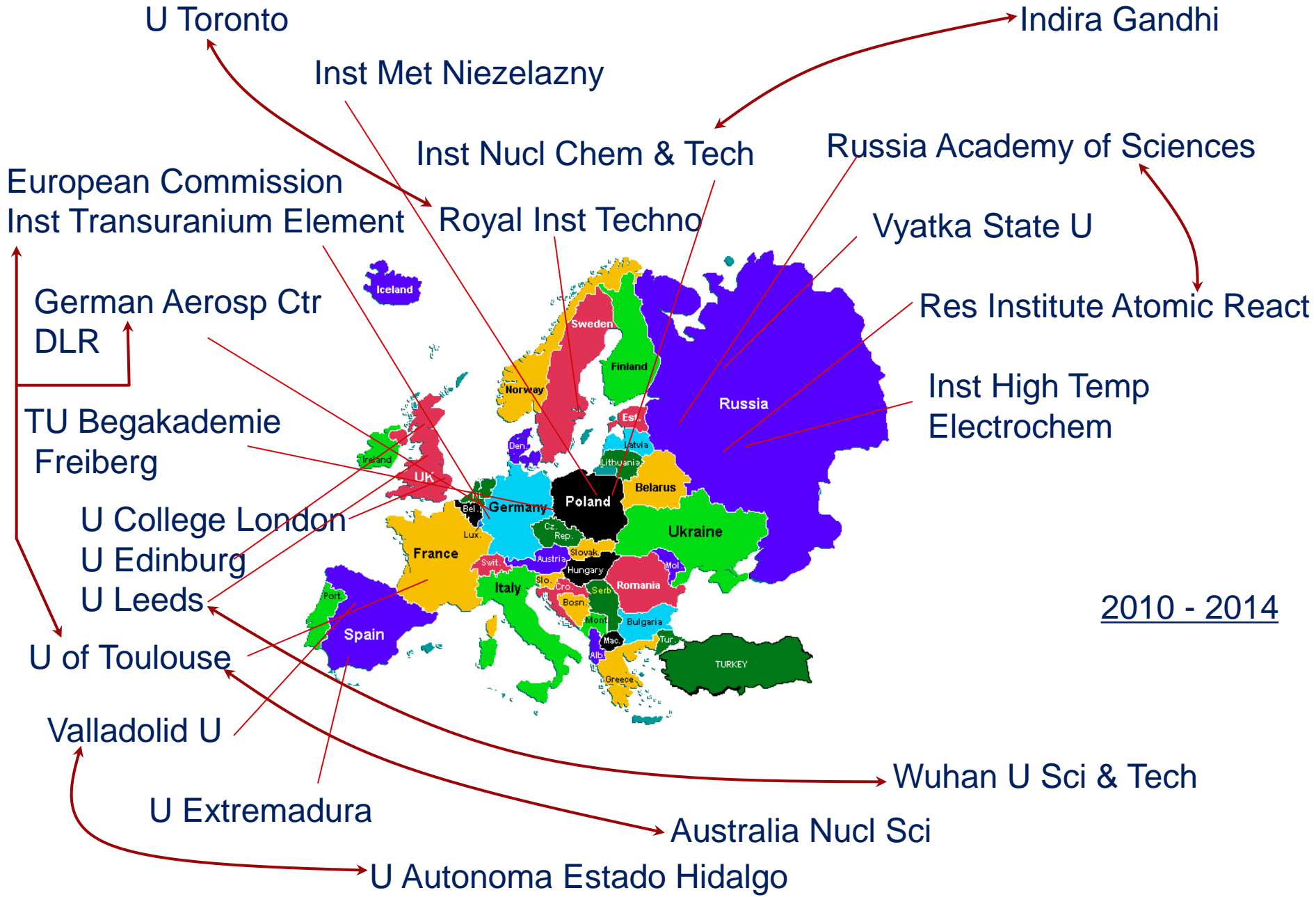

2010 - 2014

REPORTED RESEARCH ACTIVITIES IN INDIA

Inst Nucl Chem & Tech
(Poland)

Indira Gandhi Centre for Atomic Research

Bhabha Atomic Research Center

PSG Coll Technol

SRM U

Lady Doak College



Publication in Molten Salt 2010 - 2014 (over 194 papers)

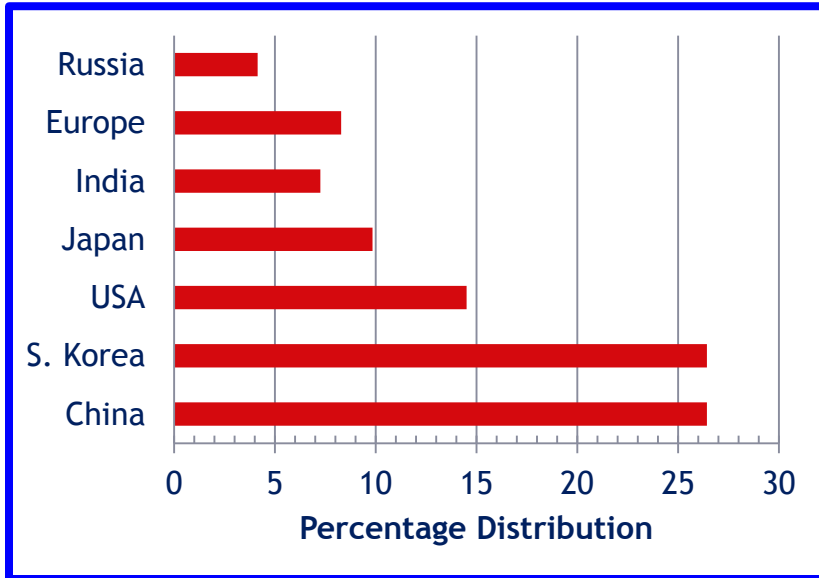

<u>Ranking</u>	<u>Journal</u>
1	Electrochimica Acta
2	Journal of Nuclear Materials
3	Journal of Radioanalytical and Nuclear Chemistry
4	Journal of Electrochemical Society
5	Journal of Nuclear Science and Technology
6	Journal of Rare Earth
7	Metallurgical and Materials Transaction B
8	Molten Salt and Ionic Liquid
9	Russian Journal of Electrochemistry
	Russian Journal of Physical Chemistry A
	Journal of Alloys and Compounds
	Acta Metallurgica Sinica
13	International Journal of Electrochemical Science
	Journal of Applied Electrochemistry
	Nuclear Technology
	Journal of Luminescence
	Transaction of Nonferrous Metals Society of China
	Electrochemistry Communications
19	Chemical Physics Letters
	Nuclear Engineering and Technology
	Rare Metals
	Corrosion
	Physical Chemistry Chemical Physics
	Chemical Research in Chinese Universities

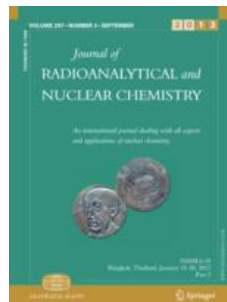

Information from Web of Knowledge

Significant findings

- Growth in molten salt interests among
 - USA
 - More work in late 2013 due to studies sponsored by DOE-NEUP.
 - China,
 - Published articles are from universities with sponsorship from governmental agencies.
 - India, and
 - Published articles are mostly from the national laboratory.
 - Japan
 - Published articles are either from the laboratories or universities collaborating with laboratories/governmental agencies.

Roadmap to success

DOE-NE

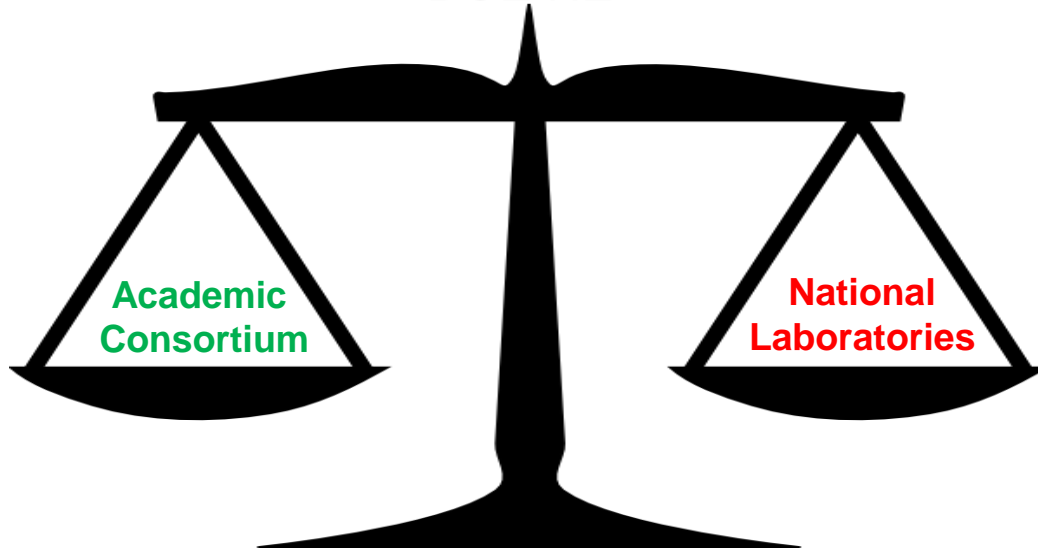

= **SUCCESSFUL
NUCLEAR FUEL
CYCLE TECHNOLOGY**

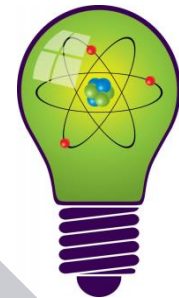

Development of the
current state
objectives

Identification of
performance targets
and outcomes

Gap analysis on the
R&D and
educational
components

Evaluation and
demonstration of
scale-up capabilities
from collected data

Notable References on Pyroprocessing Technology in the USA

- Goff, “Electrochemical Processing of Spent Nuclear Fuel,” Nuclear Regulatory Commission Seminar presentation. Rockville, MD, March 25, 2008.
- Koch, “EBR-II: An Integrated Experimental Fast Reactor Nuclear Power Station,” American Nuclear Society. 2008.
- Benedict and McFarlane, “EBR-II Spent Fuel Treatment Demonstration Project Status,” Radwaste Magazine, 23-30 July 1998.
- Chang, “The Integral Fast Reactor,” Nuclear Technology, **88**, 129-138 (1989).
- Laidler et al., “Development of Pyroprocessing Technology,” Progress in Nuclear Energy, **31**, 131-140 (1997).
- Willit et al., “Electrorefining of Uranium and Plutonium-A Literature Review,” Journal of Nuclear Materials, **195**, 229-249 (1992).
- Benedict et al., “Pyroprocessing Progress at INL,” Proceedings of Global 2007, Idaho, September 2007.
- Li et al., “Electrorefining Experience for Pyrochemical Processing of Spent EBR-II Driver Fuel,” Proceeding of Global 2005, Japan October 2005.
- National Academy of Sciences, “Electrometallurgical Techniques for DOE Spent fuel Treatment: Final Report,” National Academy Press, 2000.
- Ackerman et al., “Treatment of Wastes in the IFR Fuel Cycle,” Progress in Nuclear Energy, **31**, 141-154 (1997).

Questions?

A decorative horizontal line consisting of a solid green bar on top, followed by a white bar, and then three thin, parallel green lines on the right side.

Upcoming Webinars in the Nuclear Fuel Cycle Series

- Nuclear Waste Management-Application to Technetium
- Nuclear Repository Science and the Waste Isolation Pilot Plant
- High Level Waste

NAMP website <http://www.wipp.energy.gov/namp/>