



National Analytical Management Program (NAMP)  
U.S. Department of Energy Carlsbad Field Office

# Radiochemistry Webinars

## Environmental/Bioassay Radiochemistry Series

### *Gamma Spectrometry (Part 1)*



*In Cooperation with our  
University Partners*



UNIVERSITY of CALIFORNIA • IRVINE

# Meet the Presenters...

*Bob Shannon*

Mr. Bob Shannon has supported government and independent commercial testing laboratory radiochemistry needs for over 20 years and currently performs consulting work through Environmental Management Support (EMS). His recent project support includes drafting revision 2 of NRC RG 4.15 to incorporate MARLAP principals, developing and teaching training courses on basic radiochemistry for State and Federal lab radiochemists, performing audits for the EPA and DOE, and helping author laboratory guidance documents and develop Rapid Radioanalytical Methods for the EPA. Mr. Shannon chairs The NELAC Institute Radiochemistry Expert Committee and the ASTM D19.04 Fission and Activation Products Task Group, and is the Radiochemistry Part Coordinator for Standard Methods for the Examination of Water and Wastewater.



*David C. Burns*



Mr. David Burns has been a radiochemist and nuclear measurements analyst for 20 years. He has managed a variety of radioanalytical laboratories in the private sector, as well as state- and federal-level government laboratories. Mr. Burns provides radiochemistry consulting services through EMS, offering expertise in the areas of rapid method development, incident response, laboratory contamination control, and performance- and compliance-based laboratory assessments. Mr. Burns' other areas of expertise include radiation safety and industrial hygiene. Mr. Burns is currently the Radioanalytical Laboratory Measurements Branch Chief at the U.S. Air Force Technical Applications Center at Patrick Air Force Base.

## **Contact Information**

Dave Burns  
Phone: (970) 980-9792  
Email: [dburns@atsofcolorado.com](mailto:dburns@atsofcolorado.com)

Bob Shannon  
Phone: 218-387-1100  
Email: [Bobshannon@boreal.org](mailto:Bobshannon@boreal.org)



# Gamma Spectrometry Part 1

Introduction, Process Knowledge,  
Decay and Ingrowth, and Calibrations

*Bob Shannon*  
*David C. Burns*

**EMS**



**National Analytical Management Program (NAMP)**  
**U.S. Department of Energy Carlsbad Field Office**

TRAINING AND EDUCATION SUBCOMMITTEE



# Gamma Spectrometry Part I

This webinar is based on a workshop presented at the 2012 RRMC by Bob Shannon, Doug Van Cleef, Dave Burns and Bob Litman

# Introduction

Gamma Ray Sources, Decay Schemes,  
Gamma Interactions with Matter

# Chart of the Nuclides - Line of Stability

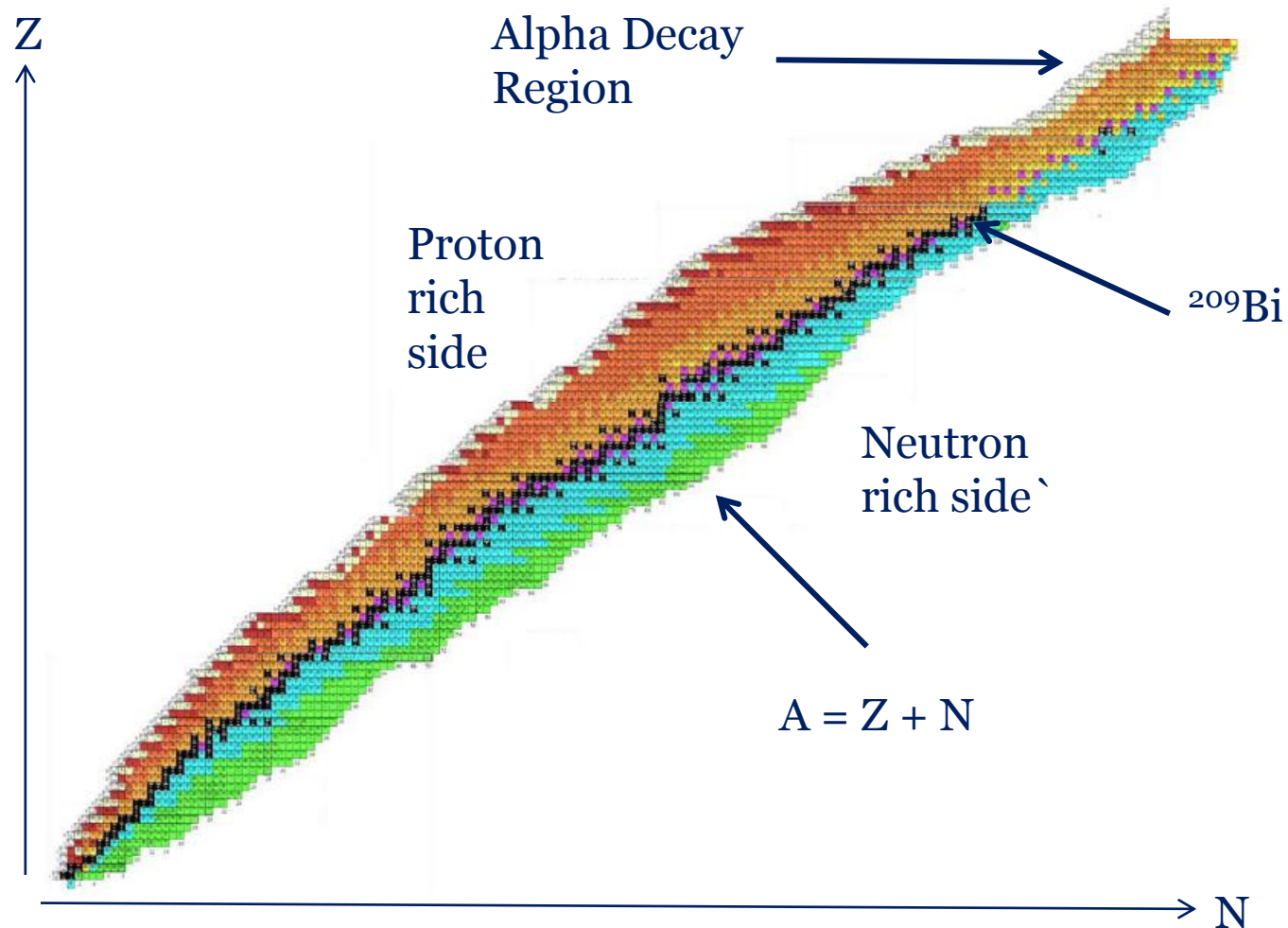





71	130Pr	131Pr	132Pr	133Pr	134Pr	135Pr	136Pr	137Pr	138Pr	139Pr	140Pr	141Pr	142Pr	143Pr	144Pr	145Pr	146Pr
73	129Ce	130Ce	131Ce	132Ce	133Ce	134Ce	135Ce	136Ce	137Ce	138Ce	139Ce	140Ce	141Ce	142Ce	143Ce	144Ce	145Ce
75	128La	129La	130La	131La	132La	133La	134La	135La	136La	137La	138La	139La	140La	141La	142La	143La	144La
77	127Ba	128Ba	129Ba	130Ba	131Ba	132Ba	133Ba	134Ba	135Ba	136Ba	137Ba	138Ba	139Ba	140Ba	141Ba	142Ba	143Ba
79	126Cs	127Cs	128Cs	129Cs	130Cs	131Cs	132Cs	133Cs	134Cs	135Cs	136Cs	137Cs	138Cs	139Cs	140Cs	141Cs	142Cs
81	125Xe	126Xe	127Xe	128Xe	129Xe	130Xe	131Xe	132Xe	133Xe	134Xe	135Xe	136Xe	137Xe	138Xe	139Xe	140Xe	141Xe
83	124I	125I	126I	127I	128I	129I	130I	131I	132I	133I	134I	135I	136I	137I	138I	139I	140I
85	123Te	124Te	125Te	126Te	127Te	128Te	129Te	130Te	131Te	132Te	133Te	134Te	135Te	136Te	137Te	138Te	139Te
N	122Sb	123Sb	124Sb	125Sb	126Sb	127Sb	128Sb	129Sb	130Sb	131Sb	132Sb	133Sb	134Sb	135Sb	136Sb	137Sb	138Sb

# Alpha ( $\alpha$ ) Decay

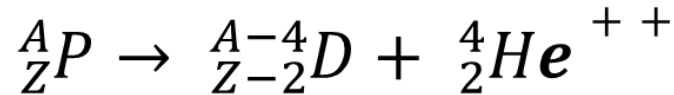
A positively charged helium atom (2 neutrons and two protons) is emitted by the parent nuclide



<p><b>Am239</b> (5<sup>-</sup>) 11.9 h</p> <p><math>\epsilon</math> <math>\gamma</math> 277.6, 228.2, ... <math>\alpha</math> 5.774 (<math>\omega</math>), 5.734, ... <math>\gamma</math> 49.3 <math>\omega</math></p> <p>E 0.802</p>	<p><b>Am240</b> (3<sup>-</sup>) 2.12 d</p> <p><math>\epsilon</math> <math>\gamma</math> 987.7, 888.8, ... <math>\alpha</math> 5.378 <math>\nu\omega</math>, ...</p> <p>E 1.38</p>	<p><b>Am241</b> 5<sup>-</sup></p> <p><math>\gamma</math> 59.5468, 20.5... SF <math>\nu\omega</math> <math>\sigma_\gamma</math> (5E1 + 63E1), (19E1 + 35E2) <math>\sigma_f</math> 3, 2, 14</p> <p>241.056829</p>
<p><b>Pu238</b> 87.7 a</p> <p><math>\alpha</math> 5.4992, 5.4565, ... <math>\gamma</math> 43.5 <math>\omega</math> (e<sup>-</sup>), 99.9 (e<sup>-</sup>), ... SF <math>\nu\omega</math> <math>\sigma_\gamma</math> 54E1, 20E1 <math>\sigma_f</math> 18, ~33</p> <p>238.049560 </p>	<p><b>Pu239</b> 1<sup>+</sup></p> <p>2.410E4 a</p> <p><math>\alpha</math> 5.156, 5.144, 5.105, ... <math>\gamma</math> 51.6 e<sup>-</sup>, 30.1 - 1057.3 <math>\omega</math> SF <math>\nu\omega</math> <math>\sigma_\gamma</math> 271, 29E1 <math>\sigma_f</math> 750, 30E1 <math>\sigma_\alpha</math> &lt; 0.4 mb</p> <p>239.052163</p>	<p><b>Pu240</b> 6.56E3 a</p> <p><math>\alpha</math> 5.1685, 5.1241, ... <math>\gamma</math> 45.2 <math>\omega</math> (e<sup>-</sup>), 104.2 (e<sup>-</sup>), ... SF <math>\nu\omega</math> <math>\sigma_\gamma</math> 290, 81E2 <math>\sigma_f</math> 0.05, 2.4</p> <p>240.053814</p>
<p><b>Np237</b> 5<sup>+</sup></p> <p>2.14E6 a</p> <p><math>\alpha</math> 4.788, 4.771, ... <math>\gamma</math> 29.4, 86.5, ... <math>\sigma_\gamma</math> 169, 65E1 <math>\sigma_f</math> 0.02, 7</p> <p>237.048173</p>	<p><b>Np238</b> 2<sup>+</sup></p> <p>2.103 d</p> <p><math>\beta^-</math> 0.263, 1.248, ... <math>\gamma</math> 984.5, 1028.5, ... <math>\sigma_\gamma</math> 48E1 <math>\sigma_f</math> 21E2, 9E2</p> <p>E 1.2915</p>	<p><b>Np239</b> 5<sup>+</sup></p> <p>2.356 d</p> <p><math>\beta^-</math> 0.438, 0.341, ... <math>\gamma</math> 106.1, 277.6, 228.2, ... <math>\sigma_\gamma</math> (3E1 + 3E1) <math>\sigma_f</math> &lt; 1</p> <p>E 0.723</p>



# Alpha Decay Gammas

Alpha emission does not *always* lead directly to the ground state of the decay product!

**Gammas  
emitted after  
alpha decay of  
 $\text{Am}^{241}$**

Decay Data Output

File Others Help

Nuclide

**Am 241** Abundance (%) 0 Mass Excess (MeV) 52.9294

Americium

Level MeV	HL	DHL	Decay Mode	Branch %	Decay Q MeV	Decay Product
G	432.2 yrs	0.7	A	100	5.638	Np 237
G	432.2 yrs	0.7	SF	4E-10	0	N/A
2.2	1.2 $\mu$ sec	0.3	SF	100	0	N/A

Decay data  Thermal neutron data

No	Rad. Type	Halflife	Rad. Energy (keV)	DE (keV)	Intensity (%)	DI (%)	Dose (gmRad/ $\mu$ Ci-H)
17	$e^-$	432.2 yrs	58.0405	0	3.40	0.4	0.0042
18	$e^-$	432.2 yrs	76.543	0.02	0.229	0.014	0.0004
19	X RAY	432.2 yrs	13.9	0	42.0	6	0.0124
20	$\gamma$	432.2 yrs	26.3448	0	2.400	0.04	0.0013
21	$\gamma$	432.2 yrs	33.196	0	0.1260	0.004	0.0
22	$\gamma$	432.2 yrs	59.54121	0	35.90	0.6	0.0455

View

B+  Gammas  Electrons  View All

B-  X-rays  Alphas

Decay Statistics

Total lines	22
B+	0
B-	0
Gamma	2

Show Decay Products

# $\beta^-$ Decay

- A neutron is converted to a proton
- Radioactive fission products are neutron rich and primarily undergo  $\beta^-$  decay

	133Cs STABLE 100%	134Cs 2.0652 Y $\beta^-$ : 100.00% $\epsilon$ : 3.0E-4%	135Cs 2.3E+6 Y $\beta^-$ : 100.00%	136Cs 13.04 D $\beta^-$ : 100.00%
	132Xe STABLE 26.9086%	133Xe 5.2475 D $\beta^-$ : 100.00%	134Xe >5.8E+22 Y 10.4357% 2 $\beta^-$	135Xe 9.14 H $\beta^-$ : 100.00%
130I 6 H 100.00%	131I 8.0252 D $\beta^-$ : 100.00%	132I 2.295 H $\beta^-$ : 100.00%	133I 20.83 H $\beta^-$ : 100.00%	134I 52.5 H $\beta^-$ : 100.00%

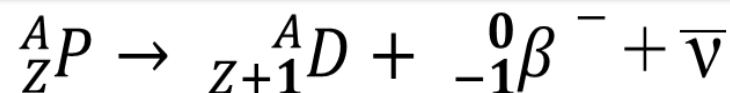

# Example: $^{133}\text{I}$ to $^{133}\text{Xe}$

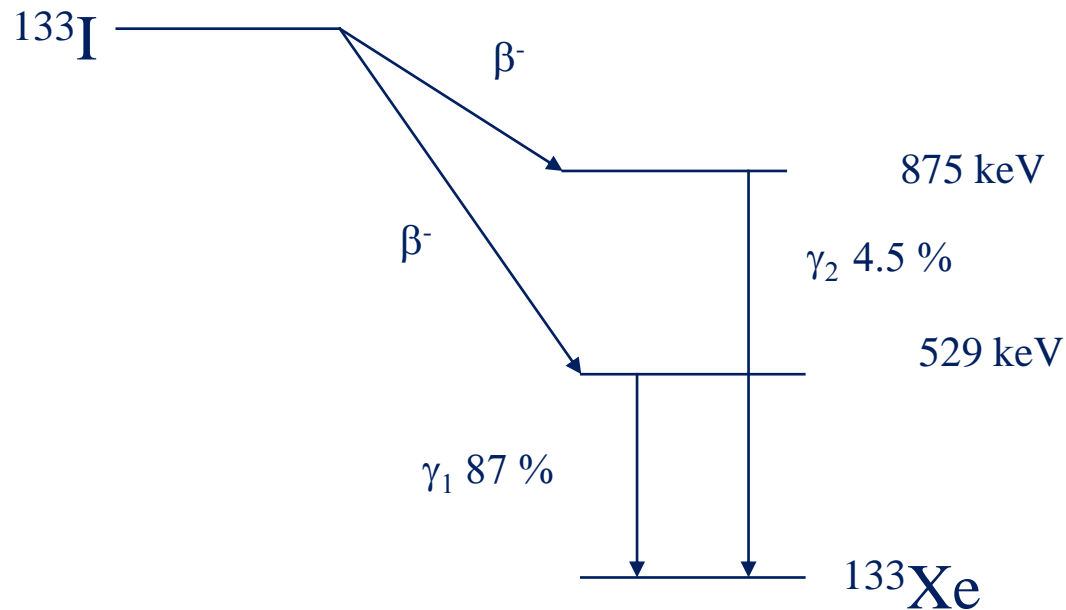

There are 44 other gamma rays with much lower abundance

# $\beta^+$ or Positron Decay

- A proton is converted to a neutron and a positron plus neutrino emitted
- Decay mode for neutron deficient nuclides; gamma emission can follow

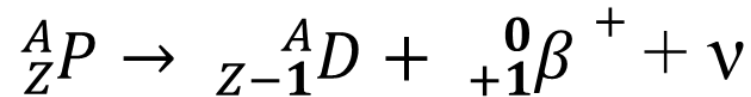

${}^{22}\text{Na}$ 2.6027 Y $\epsilon$ : 100.00%	${}^{23}\text{Na}$ STABLE 100%
${}^{21}\text{Ne}$ STABLE 0.27%	${}^{22}\text{Ne}$ STABLE 9.25%

# Electron Capture

- Competes with positron emission
- An inner electron is absorbed by the nucleus
- A proton-rich nucleus converts a proton to a neutron
- X-rays are emitted; Auger effect ensues

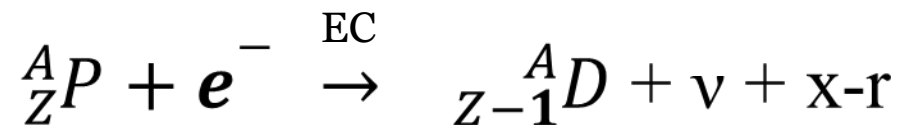

# Isomeric Transition (IT)

- Nucleus goes from an excited to ground state by emitting a gamma ray
- Can follow alpha or beta decay
- The mass number of a radionuclide that has an excited state with a half life of greater than about one second may be designated with an “m” suffix

Example:  $^{110\text{m}}\text{Ag}$  ( $t_{1/2} = 250 \text{ d}$ ) can decay either by  $\beta^-$  to  $^{110}\text{Cd}$  (stable) or by IT to  $^{110}\text{Ag}$  ( $t_{1/2} = 24 \text{ s}$ )

# Internal Conversion

An excited state of a nucleus can transfer its energy directly to an electron (which is then ejected), instead of the excited state de-exciting by emission of a gamma ray

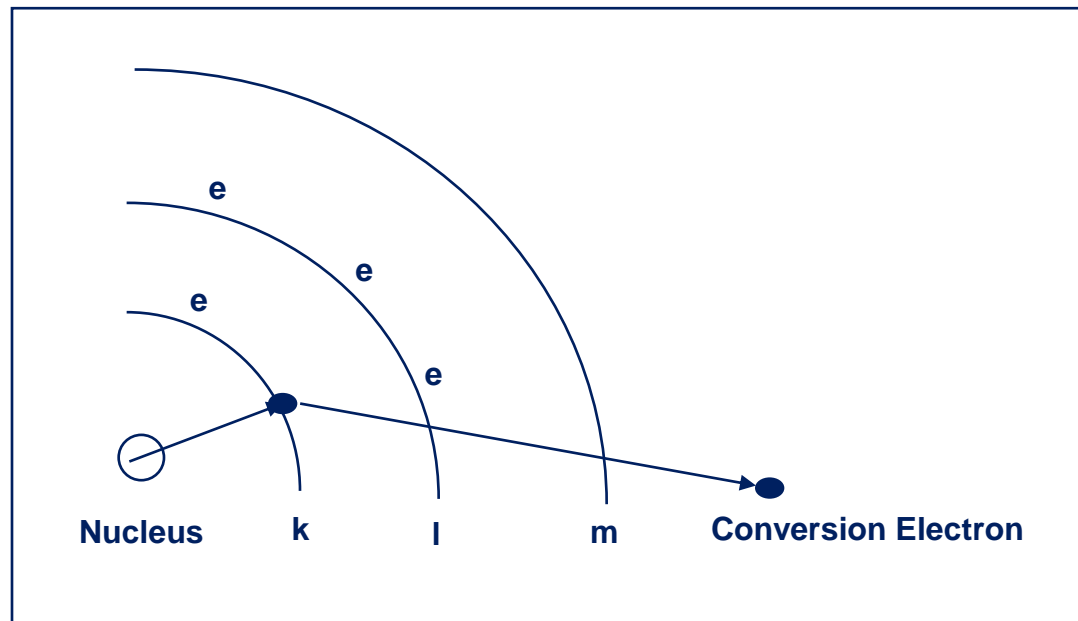

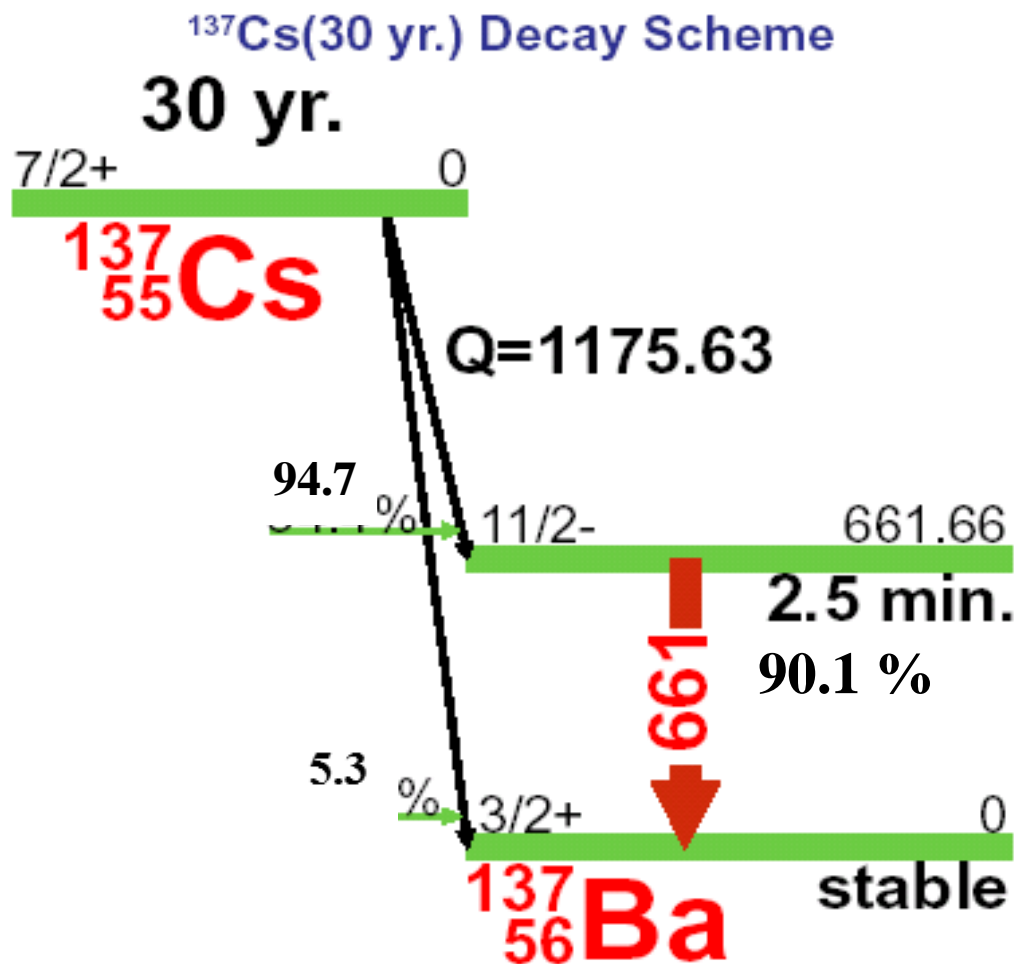

$$(0.947) \times (0.901) = \mathbf{0.853}$$



# Internal Conversion

Internal conversion competes with gamma emission...

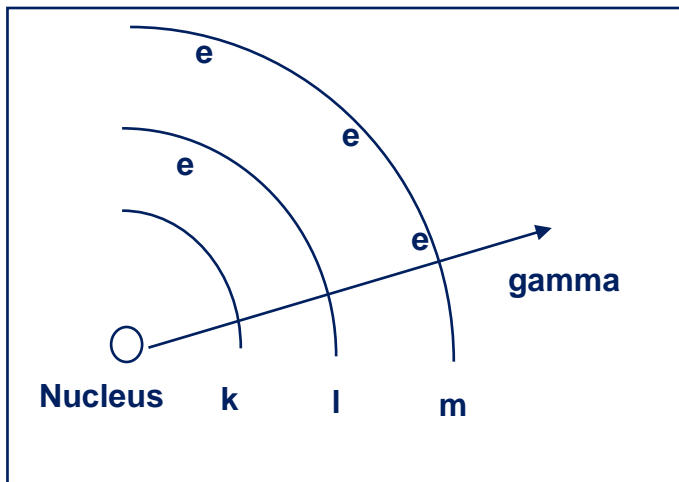

versus

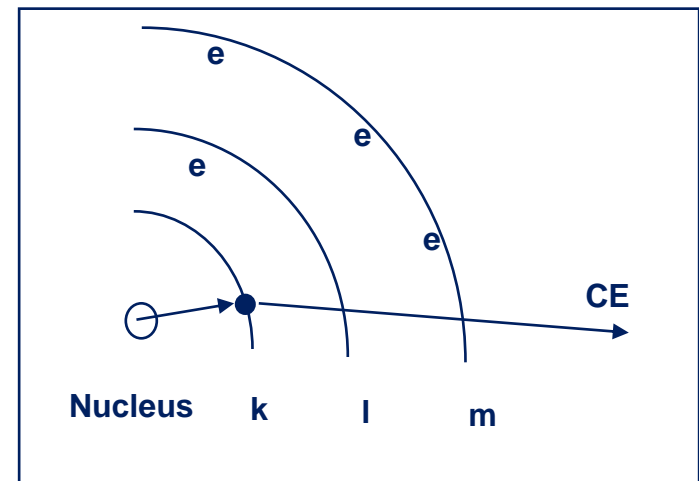

**Note that this electron energy is discrete!**

# Isomeric Transition: Gamma Emission

- Radioactive decay frequently results in progeny nuclei that are not at ground state. Instead, the nucleus of the decay product is at some excited level
- The isomeric states formed from beta decay typically have half-lives measured in nanoseconds and rapidly decay to other isomeric or ground state by emitting photons

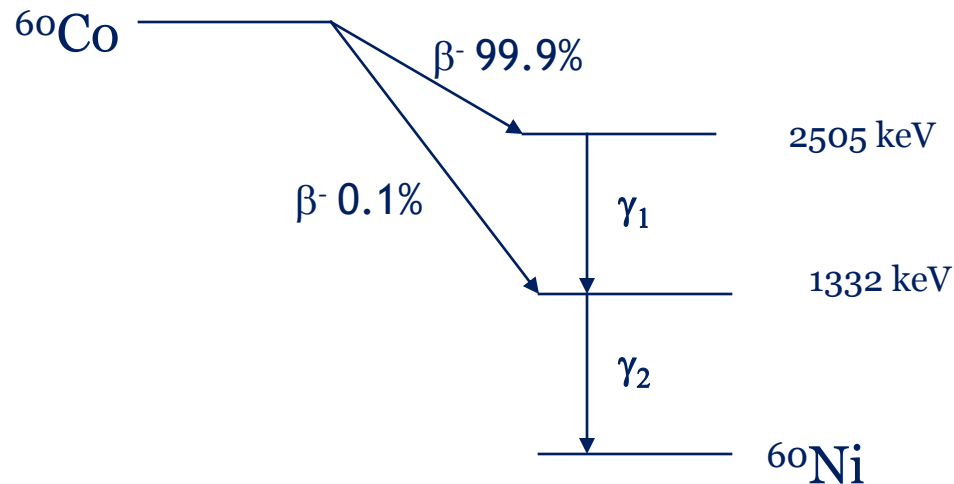

$$\gamma_1 = (2505.7 - 1332.5) = 1173.2 \text{ keV}$$

$$\gamma_2 = (1332.5 - 0) = 1332.5 \text{ keV}$$

# Photon Interactions with Matter

There are three interactions by which photons interact with matter that are important in gamma spectrometry:

- Photoelectric effect
- Compton scattering
- Pair production

# Photoelectric Effect

Principal reaction mechanism of low energy\* photons

**Incident Photon**  
Transfers all its energy  
to the bound electron

$\gamma$

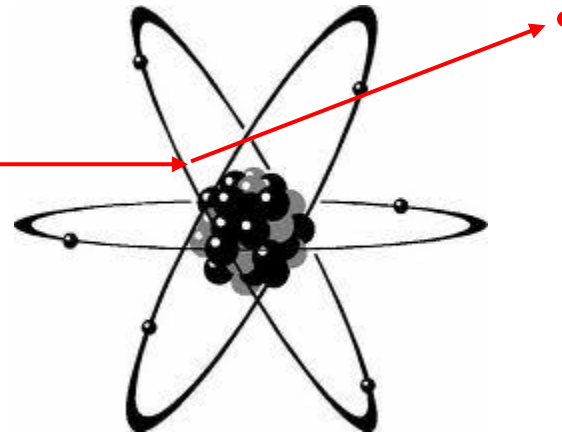

**Ejected Photo Electron – contains the  
energy of the incident gamma ray**

*When this occurs within the  
active volume of a detector,  
a count is added to the area  
of a full energy peak*

*\* Predominates at < 140 keV*

# Gamma Interactions & Full-Energy Detection

- Gamma emission energies are discrete (a.k.a. monoenergetic)
- Gamma rays can interact with the sample, the container or the detector
- Gamma rays that interact by the photoelectric effect in the detector yield a count in the full energy peak (FEP)

# Compton Scattering

- Compton Scattering is the primary interaction for gamma photons of medium energy\*
- The interactions occur over a broad energy range
- Minimum energy of the scattered gamma ray =  $180^\circ$  deflection

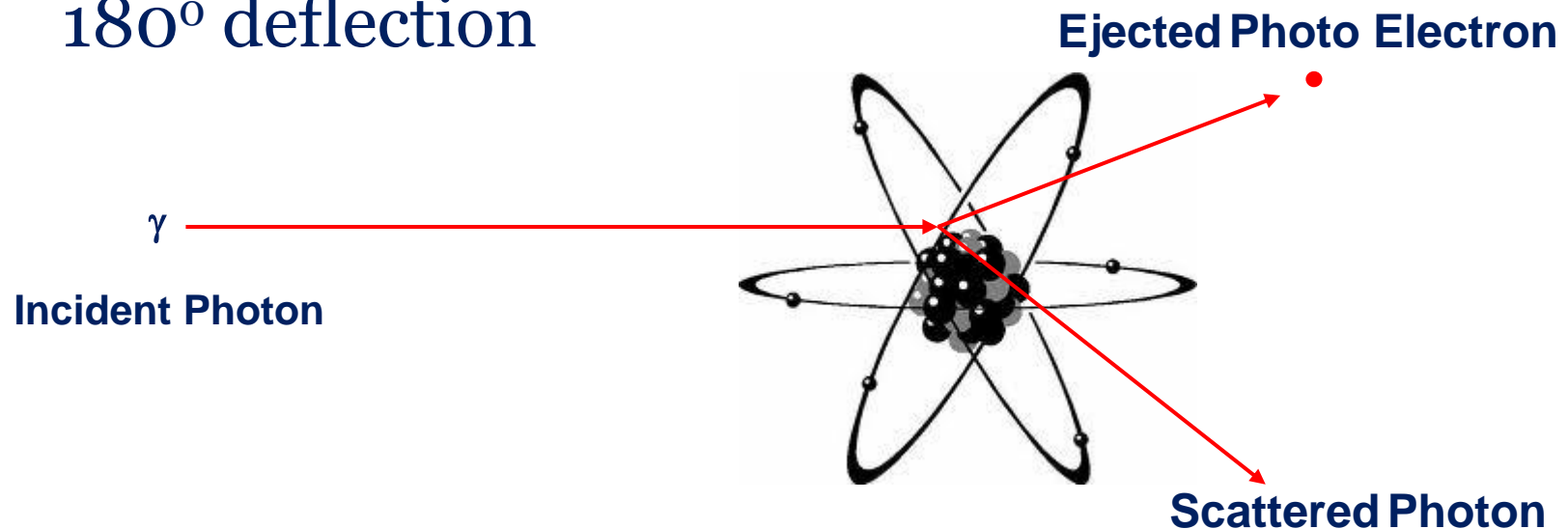

*\* Predominates between 140 keV and 2 MeV*

# Compton Effect

- The full energy of the photon is unevenly shared over a wide energy range between the scattered electron and gamma ray
- The  $E_{\text{max}}$  of the scattered electron (in the detector) is at the Compton edge

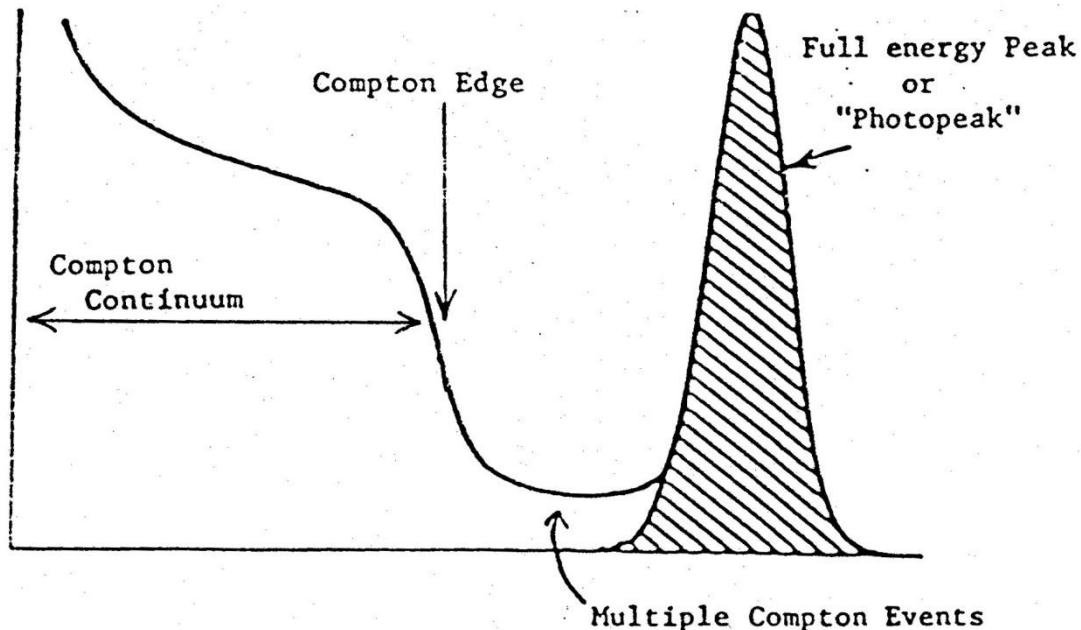

# Compton Edge Location

$$E_{\text{max electron}} = E_{\gamma} - \frac{0.511E_{\gamma}}{[0.511+2E_{\gamma}]}$$

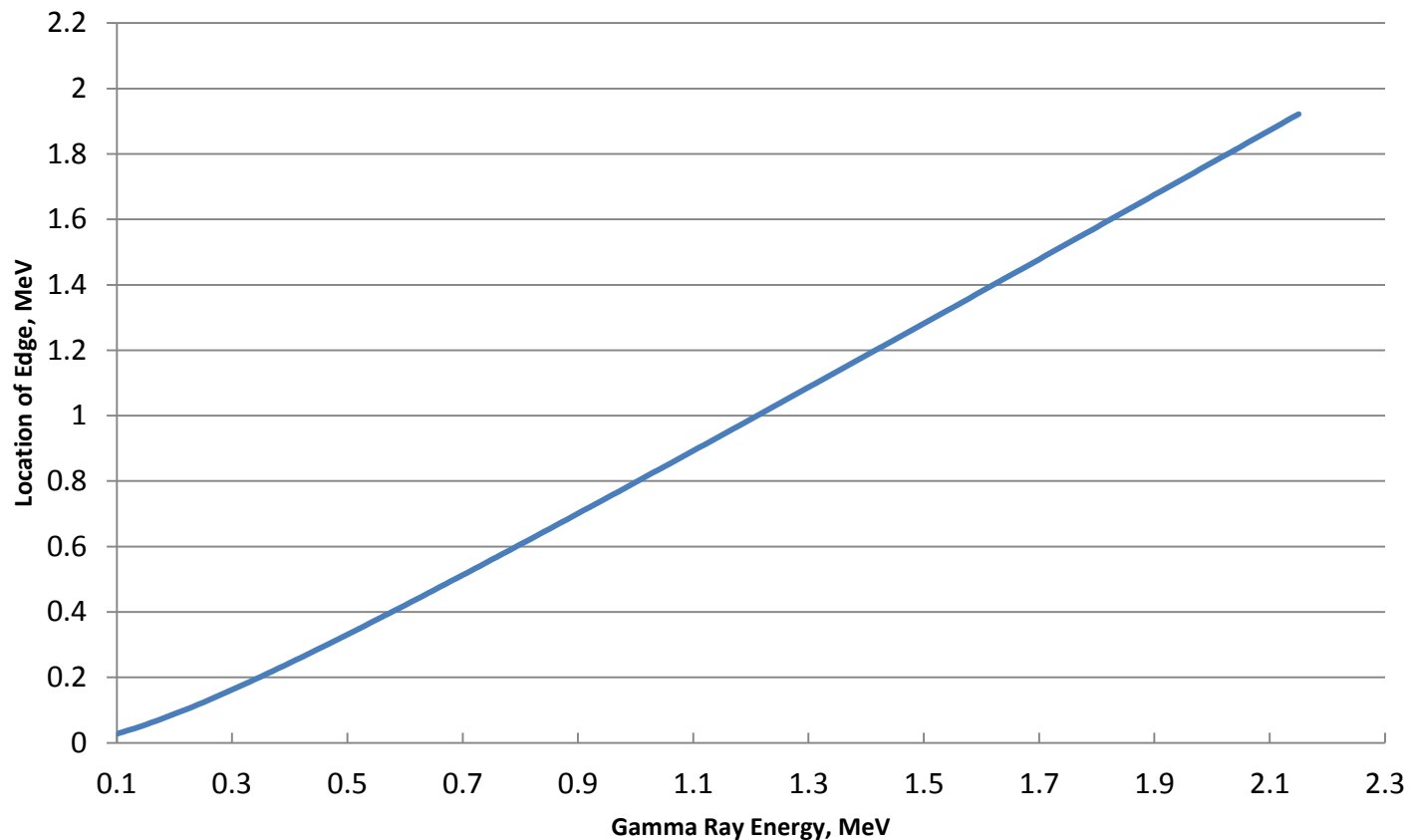



# Effect of Detector Size on Compton

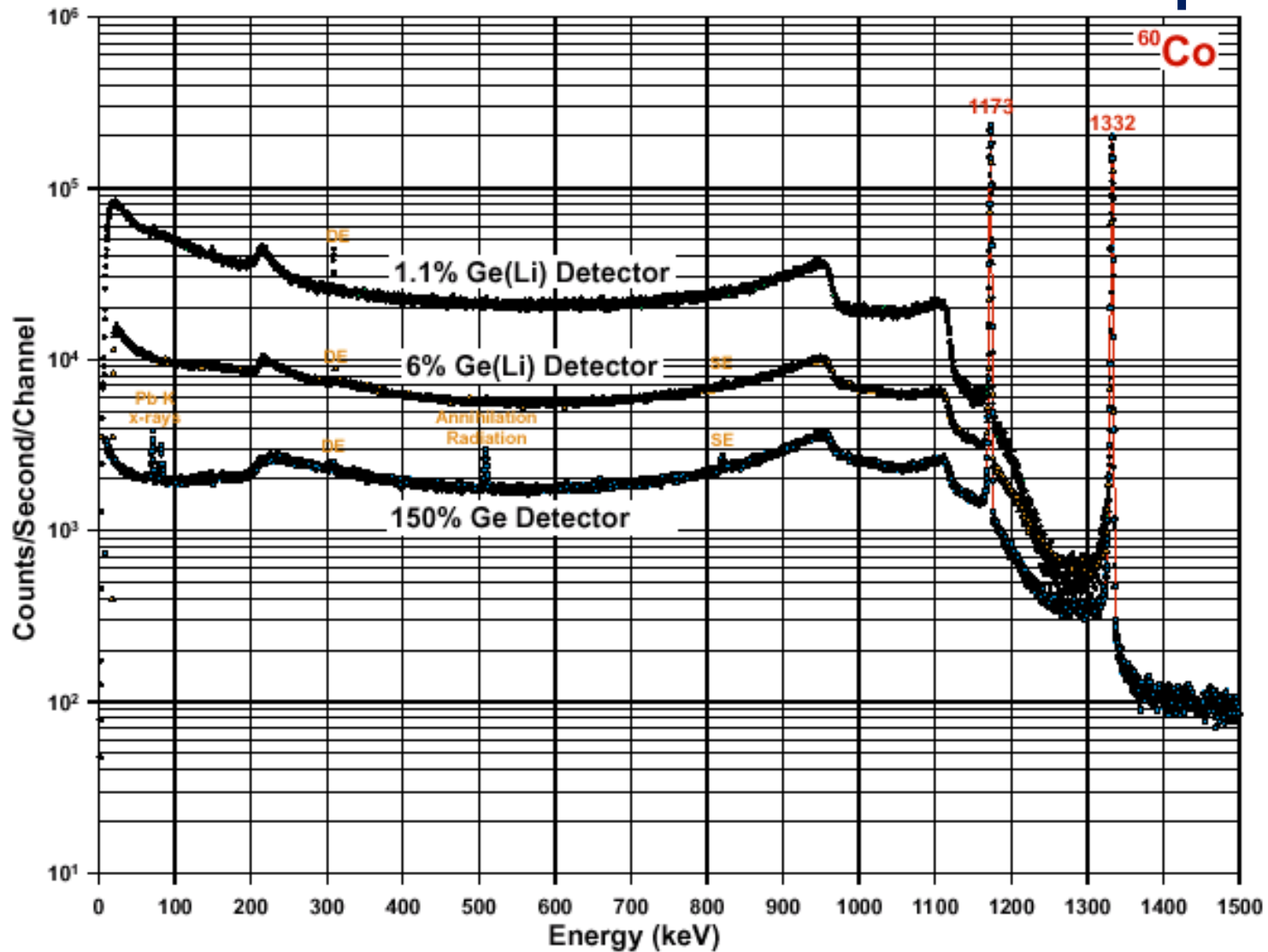

# Backscatter Peak

- Backscatter peaks are caused by the detection of photons that have undergone a large angle scattering event (Compton scattering) prior to interacting with the detector
  - Backscatter is mainly from shielding
  - Energy depends on the scattered angle
- When observing the energy dependence of the scattered gamma rays as a function of the scattering angle, any scattering angle greater than about  $120^\circ$  results in scattered photons of nearly identical energy
- Typical energy is 0.2 to 0.25 MeV

# Spectrum with Backscatter Peak

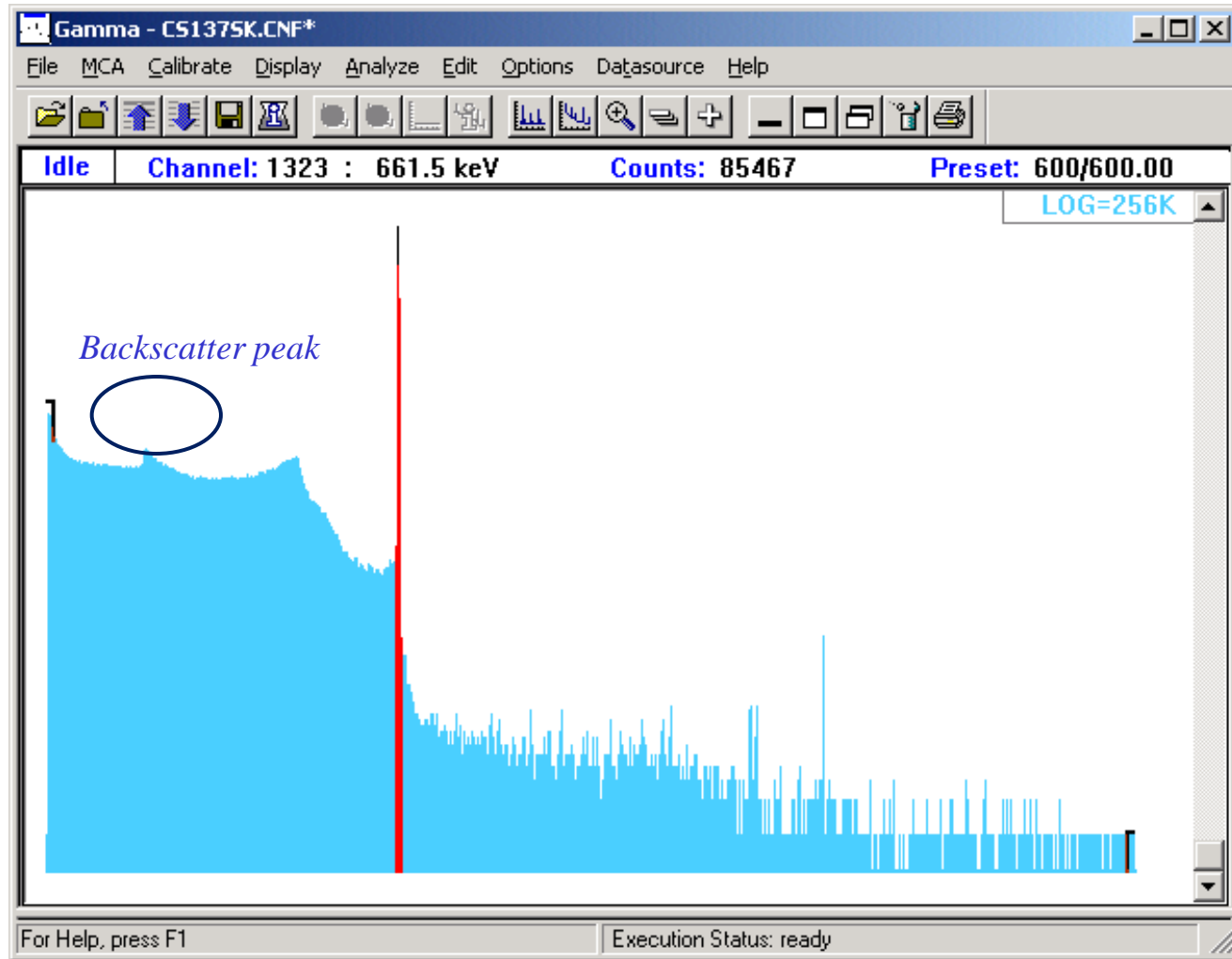

# Pair Production

Primary interaction mechanism for high energy\* gamma photons

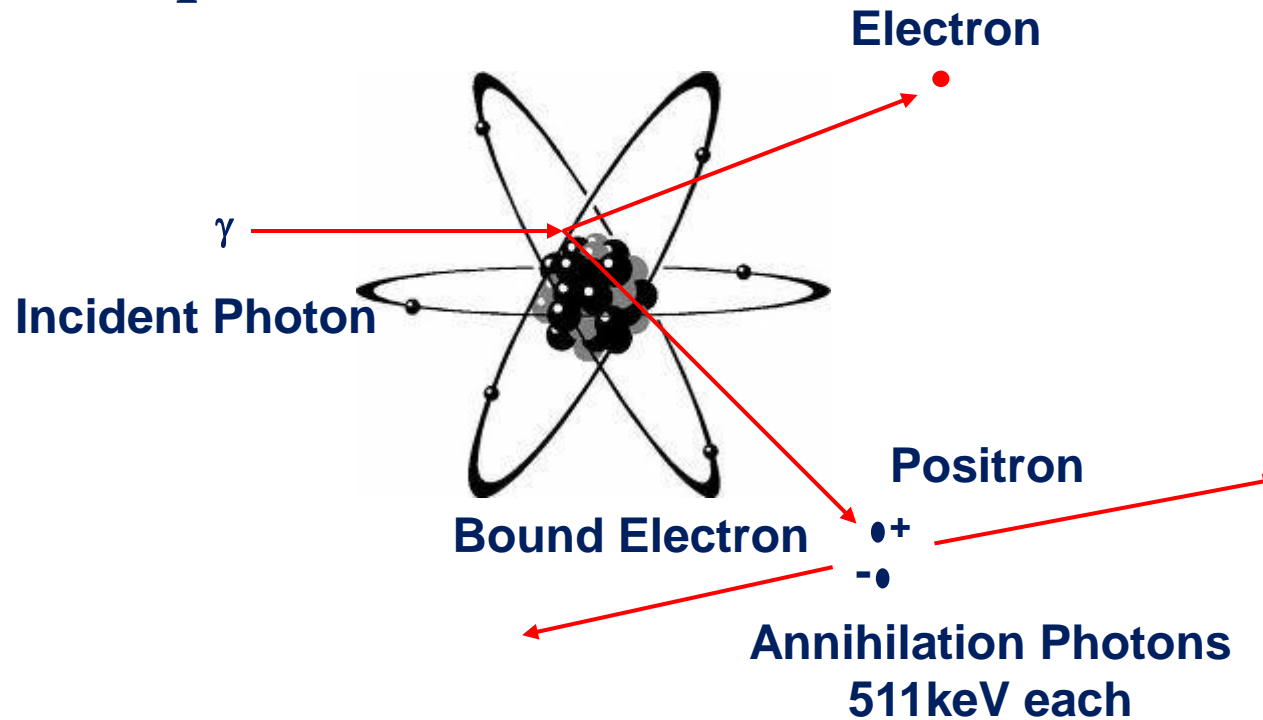

*\* Predominates at > 2 MeV*

# Pair Production

- When pair production occurs within the detector:
  - A single escape peak ( $E_\gamma - 511 \text{ keV}$ ), or
  - A double escape peak ( $E_\gamma - 1022 \text{ keV}$ )
- May be observed
- If the pair production occurs outside the detector, a 511 keV peak may be observed
- Each resembles a *real* gamma ray: don't be fooled!

# Example Spectrum from Y-88 Decay

Page -275-

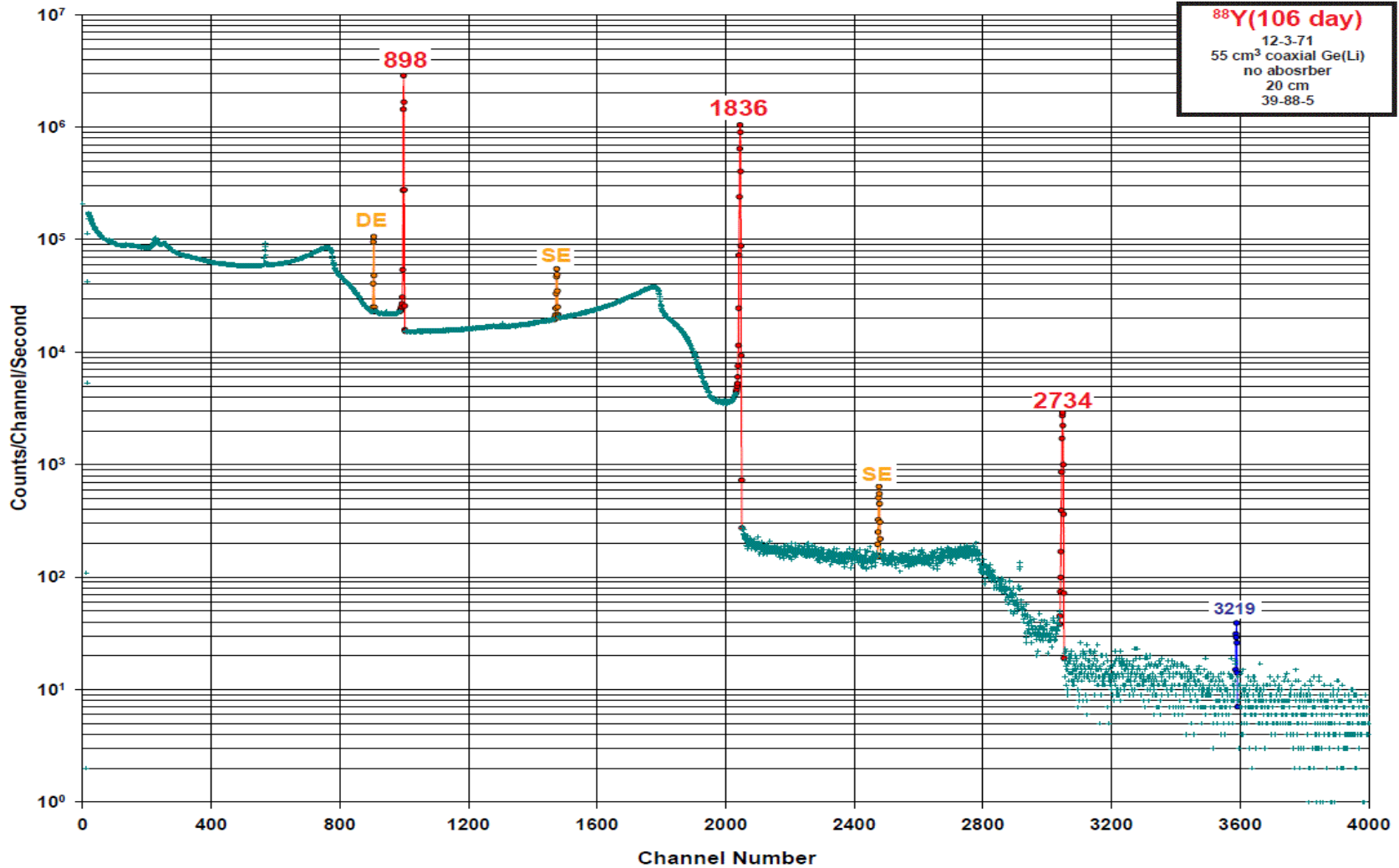

# Process Knowledge

Perhaps the most important thing you can know to help you get the right answer...

# Process Knowledge

- *A thorough understanding of the history of the sample, where it came from, and what happened to it along the way*
- *Includes the expectations of the client, and the intended use of the data*
- *Can (in many cases) significantly reduce the analyte list, simplify the analysis, and expedite the investigation of spectral “peculiarities”*



# Process Knowledge

Know these things before you start:

- Where did the sample come from?
- What was it before it was a sample?
- How did it become a sample?
- Whoever sent it to you, what do they *really* want to know, and why?

# Where did the sample come from?

Information regarding the origin of the sample and the processes to which it was subjected can significantly reduce the scope of potential analytes



# Where did the sample come from?

- Natural/Agricultural Area
  - Naturally Occurring (??)
  - Complete decay chains (??)

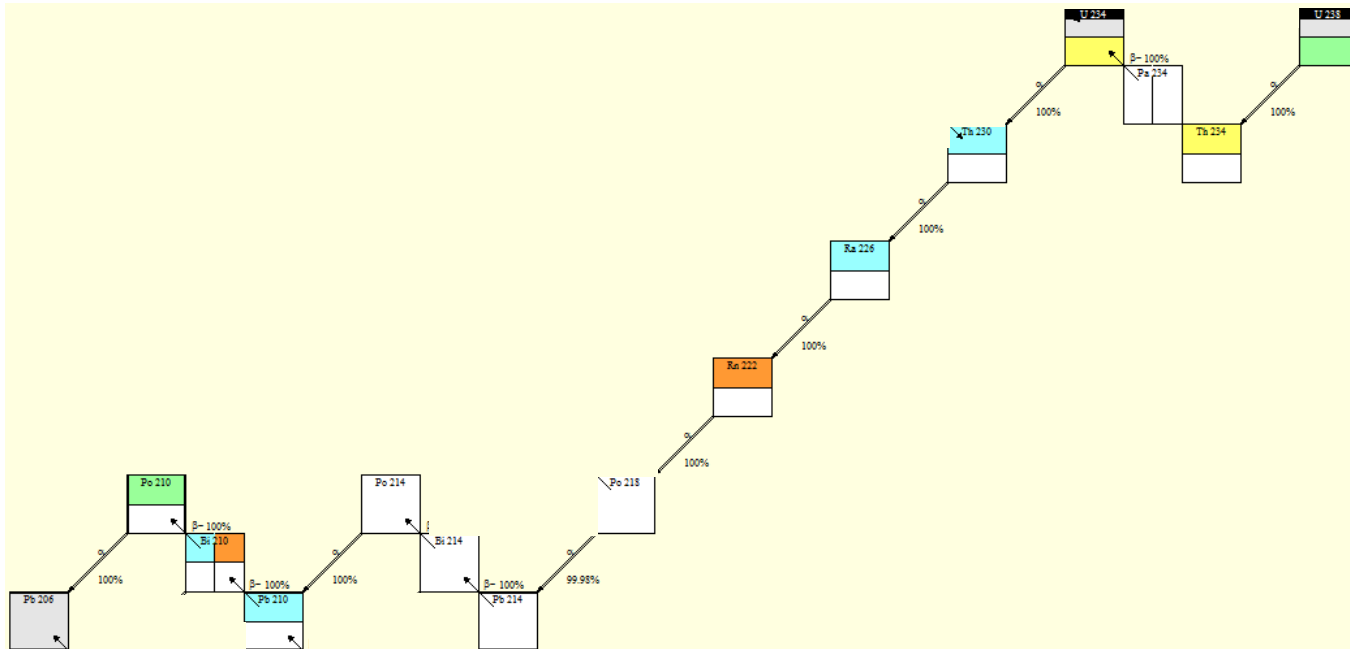

# Where did the sample come from?

- Mining
  - NORM, TENORM
  - Disequilibrium in decay chains?

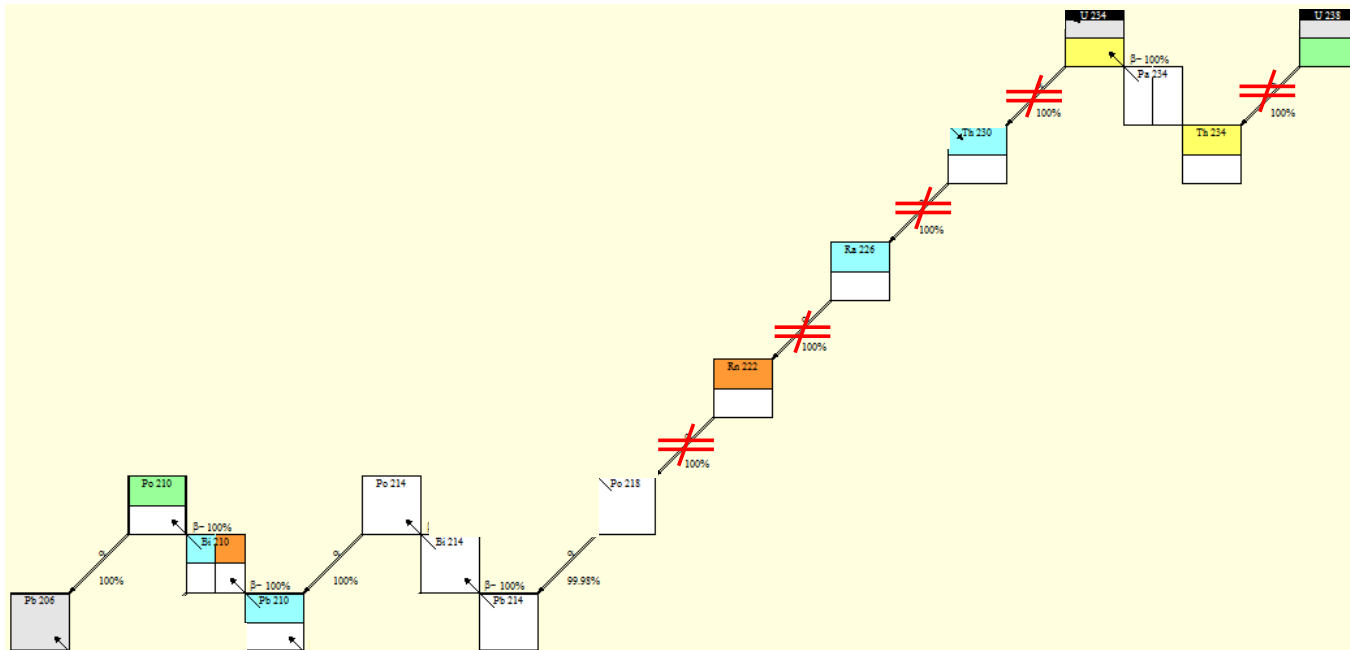

# Where did the sample come from?

- Nuclear Power Plants
- Weapons Production
- Isotope Production
- Research
  - Fission / Activation Products
  - Narrow list of potential nuclides?
  - NORM included?



# Where did the sample come from?

- Process Waste
- “Legacy” Waste
  - Type of Facility
  - Age of the Material



# What was it before it was a sample?

No, *really*, what was it?



# What was it before it was a sample?

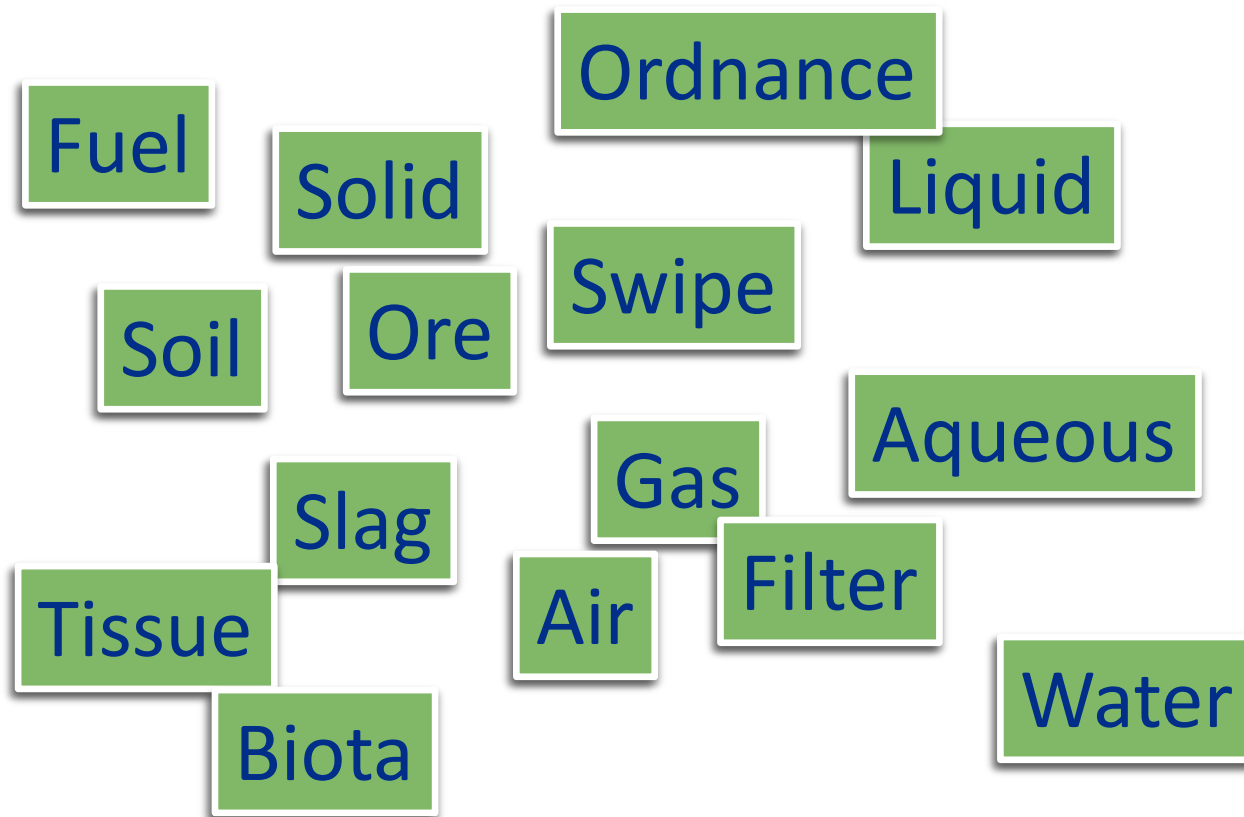



# What was it before it was a sample?

Consider the Process Phase...

- Influent/Effluent
- Geologic/Mill Tailings/Slag
- Fuel Production/Spent Fuel Handling
- Feedstock/Process Waste
- Contaminated/Activated

# How did it become a sample?

Does the sampling process itself have an effect on radionuclides collected?



Whoever sent it to you, what do they *really* want to know, and why?

“We want to know everything that’s in the sample...”

“Do whatever you normally do...”

“Give us your lowest detection limits...”

“I just need a regular gamma scan...”

“Don’t report anything in the sample except for...”

# What is the purpose of the analysis?

- Waste characterization
- Risk assessment
- Decontamination and decommissioning
- Release

Are there regulatory or procedural limits that might affect these decisions?

# What is on the requested list of analytes and why?

Symbol	Radionuclide	Physical Half-Life	Half-Life Units	Ag PRG (pCi/g)	Estimated Analytical Method	Estimated Best MDC (pCi/g)	Ag PRG Met (estimated)?	Likely Parents	Radioactive Daughters	Comment	Failed Selection Criteria
Ac-227	actinium-227+D	21.772	Years	0.0831	AS	0.042	Yes	Ra-227/Pa-231	Th-227+D/Fr-223+D	Ra-227 and parents have a very short half-life. Fr-223 and daughters have a very short half-life. Th-227 and daughters have a very short half-life.	Pass
Ac-228	actinium-228	6.15	Hours	731	GS	0.225	Yes	Ra-228	Th-228+D	None	Pass-Parent
Ag-108	silver-108	2.37	Minutes	6010000	TBD	TBD	TBD	Ag-108m	None	None	Pass-Parent
Ag-108m	silver 108m	418	Years	0.00629	GS	0.0398	No	None	Ag-108	None	Pass
Ag-110	silver-110	24.6	Seconds	17600000	TBD	TBD	TBD	Ag-110m	None	None	3
Ag-110m	silver-110m	249.76	Days	0.152	GS	0.0391	Yes	None	Ag-110	None	3
Ag-111	silver-111	7.45	Days	13.6	TBD	TBD	TBD	Po-111	None	Po-111 and parents have a very short half-life.	3
Al-28	aluminum-28	2.2414	Minutes	58400	TBD	TBD	TBD	Mg-28	None	None	3
Am-241	americium-241	432.6	Years	0.0132	AS	0.0939	No	Pu-241/Cm-241	Np-237+D	None	Pass
Am-243	americium-243+D	7.370	Years	0.0111	AS	0.0466	No	Pu-243/Bk-247	Np-239+D	Parents of Bk-247 (1380 year half-life) have a very short half-life. Pu-243 and parents have a very short half-life, except for Cm-247 (1.56E+7 year half-life) and Cf-251 (958 year half-life).	Pass
Ar-39	argon-39	269	Years	148	TBD	TBD	TBD	Cl-39	None	None	2
Ar-41	argon-41	109.61	Minutes	1740	GS	4.14	Yes	Cl-41	None	Cl-41 and parents have a very short half-life.	3
As-76	arsenic-76	1.0942	Days	365	TBD	TBD	TBD	None	None	None	3
As-77	arsenic-77	38.83	Hours	8190	TBD	TBD	TBD	Ge-77	None	Ge-77 and parents have a very short half-life.	3
Ba-133	barium-133	10.5	Years	0.161	GS	0.004	Yes	Ba-133m/La-133	None	Ba-133m and La-133 and parents have a very short half-life.	Pass
Ba-135m	barium-135m	28.7	Hours	4020	TBD	TBD	TBD	None	None	None	3
Ba-137m	barium-137m	2.552	Minutes	178000	GS	TBD	TBD	Ce-137/La-137	None	Parents of La-137 (6E+4 years half-life) have a very short half-life.	Pass-Parent
Ba-139	barium-139	83.06	Minutes	88900	GS	30.7	Yes	Cs-139	None	Cs-139 and parents have a very short half-life.	3
Ba-140	barium-140	12.7527	Days	83.7	GS	0.197	Yes	Ce-140	La-140	Ce-140 and parents have a very short half-life.	3
Be-10	beryllium-10	1.51E+06	Years	11.6	LS	2.253	Yes	None	None	None	Pass
Bi-210	bismuth-210	5.012	Days	1340	TBD	TBD	TBD	Pb-210/At-214	Po-210	At-214 and parents have a very short half-life.	Pass-Parent
Bi-212	bismuth-212	60.55	Minutes	22400	GS	0.763	Yes	Pb-212/At-216	Po-212+D/Tl-208	At-216 and parents have a very short half-life. Po-212 has a very short half-life and no radioactive daughters.	Pass-Parent
Bi-214	bismuth-214	19.9	Minutes	8190	GS	0.112	Yes	Pb-214/At-218	Po-214+D	At-218 and parents have a very short half-life. Po-214 and daughters have a very short half-life except for Pb-210.	Pass-Parent
Bk-249	berkeilium-249	330	Days	6610	TBD	TBD	TBD	Cm-249/Es-253	Cf-249+D	Cm-249 and Es-253 and parents have a very short half-life.	3
Br-82	bromine-82	35.282	Hours	45.8	TBD	TBD	TBD	Br-82m	None	Br-82m does not have a parent.	3
C-14	carbon-14	5,700	Years	0.0000563	LS	0.028	No	B-14	None	B-14 and parents have a very short half-life.	Pass
Ca-45	calcium-45	162.61	Days	31.4	TBD	TBD	TBD	K-45	None	K-45 and parents have a very short half-life.	3
Ca-47	calcium-47	4.536	Days	32.4	TBD	TBD	TBD	K-47	Sc-47	K-47 and parents have a very short half-life. Sc-47 half-life has a very short half-life.	3
Cd-109	cadmium-109	461.4	Days	0.266	GS	0.819	No	In-109	None	In-109 and parents have a very short half-life.	3
Cd-113	cadmium-113	7.7E+15	Years	0.0028	TBD	TBD	TBD	Ag-113	None	Ag-113 and parents have a very short half-life.	Pass
Cd-113m	cadmium-113m	14.1	Years	0.00526	TBD	TBD	TBD	None	None	None	Pass
Cd-115	cadmium-115	53.46	Hours	27.1	TBD	TBD	TBD	Ag-115	In-115m	Ag-115 and parents have a very short half-life.	3
Cd-115m	cadmium-115m	44.56	Days	0.75	TBD	TBD	TBD	None	In-115	None	3
Xe-133m	xenon-133m	2.19	Hours	4180	TBD	TBD	TBD	I-135	Xe-133	None	2,3
Xe-135	xenon-135	9.14	Hours	2300	GS	0.0900	Yes	I-135	Cs-135	None	2,3
Xe-133m	xenon-133m	2.19	Hours	4180	TBD	TBD	TBD	I-135	Xe-133	None	2,3
Xe-135	xenon-135	9.14	Hours	2300	GS	0.0900	Yes	I-135	Cs-135	None	2,3
Xe-133m	xenon-133m	2.19	Hours	4180	TBD	TBD	TBD	I-135	Xe-133	None	2,3
Xe-135	xenon-135	9.14	Hours	2300	GS	0.0900	Yes	I-135	Cs-135	None	2,3
Xe-133	xenon-133	5.243	Days	2440	TBD	TBD	TBD	I-135	Xe-133m	None	2,3
Xe-133m	xenon-133m	2.19	Hours	4180	TBD	TBD	TBD	None	Xe-133	None	2,3
Xe-135	xenon-135	9.14	Hours	2300	GS	0.0900	Yes	I-135	Cs-135	None	2,3

173 potential gamma-emitting analytes

# What are the requested measurement quality objectives?

- “Detection Limit”
  - MDC
  - Critical Level
- Requested Uncertainty?
  - Standard (Counting) Uncertainty
  - Combined Standard Uncertainty
  - Coverage Factor
  - At what activity level?
- **Why?**

Whoever sent it to you, what do they *really* want to know, and why?

- What is the expected end-use of the data?
- Does the analytical request support that end use?

# Decay and Ingrowth Correction of Gamma Spectrometry Measurements



# Gamma Spectrometry Decay and Ingrowth

- The “***Industry Standard***” is:
  - Measure radioactivity “today”
  - Decay correct to a point in the past
- Most frequently, commercial gamma spectrometry software is used to calculate decay-corrected results

# Dealing with the Software...

## Half-Life Corrections: Friend or Foe?

- Decay correction routines in gamma software are of limited scope
  - Gamma software decay corrections generally assume *unsupported decay* for all the radionuclides
  - Data inputs:
    - Sample collection (or other reference date)
    - Half-life data as entered into the library
    - Sample count date/time
    - Activity at time of the count

*Note: software packages provide different levels of support for more complex decay relationships. Some labs have extensively customized software to support more complex corrections.*

# Radioactive Decay

## Everything Starts and Ends with Atoms

The basic decay equation relates the number of atoms of a radionuclide ( $N$ ) to its radioactivity ( $A$ ) through its half-life.

$$A = \lambda N$$

$$\lambda = \frac{\ln(2)}{t_{1/2}} = \frac{0.6931}{t_{1/2}}$$

The units for the decay constant,  $\lambda$ , are inverse time (e.g.,  $\text{sec}^{-1}$  or  $\text{min}^{-1}$ )

# The Correction Implemented in Most Software: Unsupported Decay

- Occurs in a radionuclide ( $N_p$ ) when no new atoms of the radionuclide are being produced
- Unsupported radionuclides decay with their characteristic half-life

$$\lambda_p N_p^1 = \lambda_p N_p^0 (e^{-\lambda_p \Delta t}) \qquad A_p^1 = A_p^0 (e^{-\lambda_p \Delta t})$$

$$A_p^0 = \frac{A_p^1}{e^{-\lambda_p \Delta t}}$$

***Notation used throughout this module...***

$\lambda_p$  and  $\lambda_d$  are the decay constants for **P**arent and **D**ecay progeny, respectively

$\Delta t$  = time elapsed between the reference date,  $T_0$  and the count date,  $T_1$

$N_p^0, N_d^0$  &  $A_p^0, A_d^0$  are atoms & activity of **P**arent & **D**ecay progeny at time  $T_0$ , respectively

$N_p^1, N_d^1$  &  $A_p^1, A_d^1$  are atoms & activity of **P**arent & **D**ecay progeny at time  $T_1$ , respectively

# Where Did *THAT* Come From?!?!?

- A lab measures  $^{212}\text{Pb}$  ( $t_{1/2} = 10.64 \text{ h}$ ) in soil on January 9:

$$1.50 \pm 0.15 \text{ pCi/g}$$

- The software decay corrects the result to the date of collection on January 3 using EverySample.Lib
- The decay corrected result is reported to the customer:

$$17,800 \pm 1,800 \text{ pCi/g}$$

What went wrong with this result?

# Unsupported Decay of $^{212}\text{Pb}$

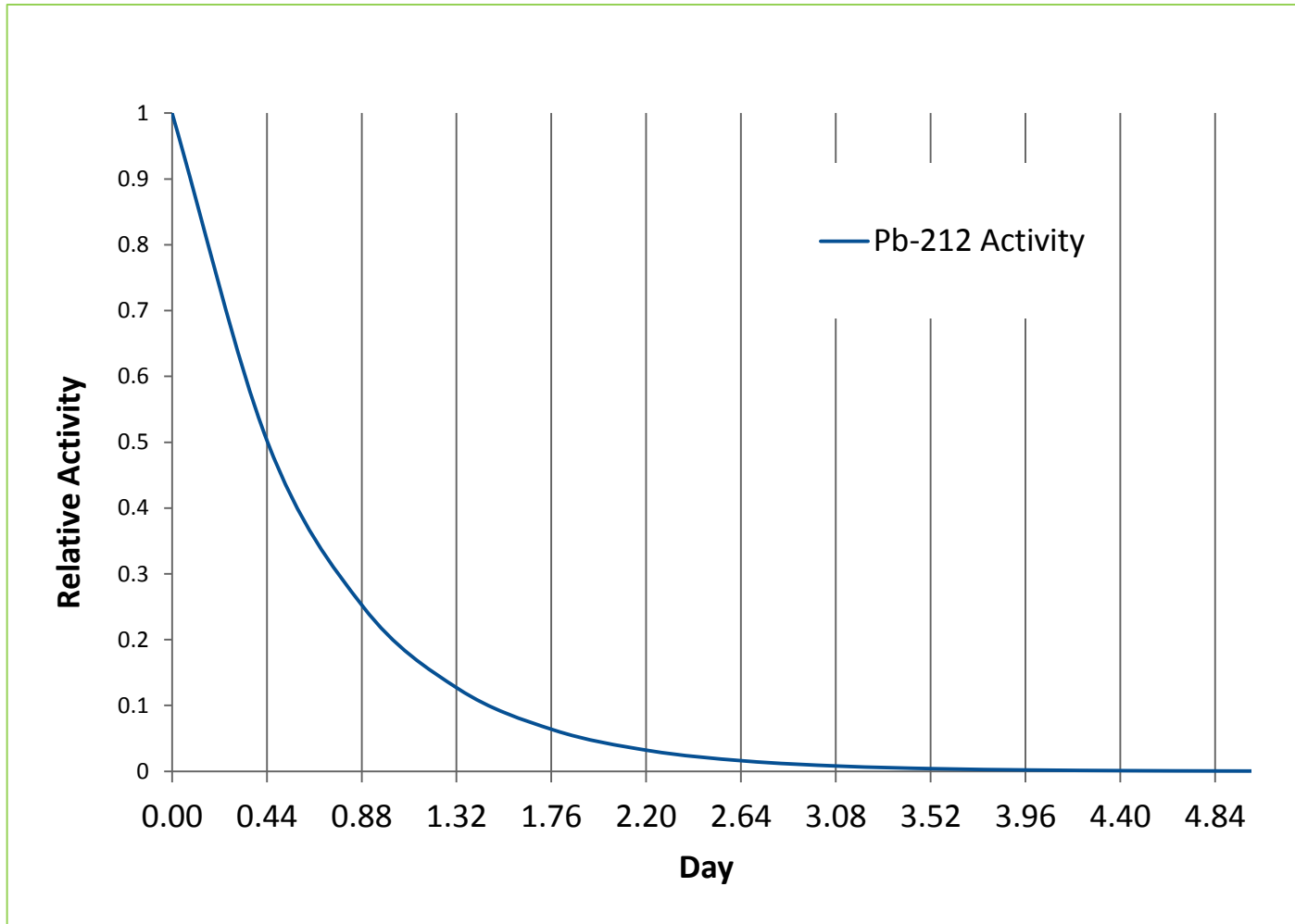

# Decay Chains Supported Decay and Ingrowth

- A radionuclide's activity is said to be “supported” if atoms of the radionuclide are being replenished by its decay chain parent
  - The decay rate of the parent is a function of the number of atoms of parent present and its half-life
  - Each decay of parent (usually) results in the formation of an atom of one decay progeny
  - Atoms of progeny may also have been present at the beginning of the decay period ( $t_0$ )
  - The rate that atoms of progeny decay (i.e., activity), depends on the number of progeny atoms present and the progeny half-life

# Progeny Activity for Supported Decay/ Ingrowth

$$N_d^1 = N_d^0 e^{-\lambda_d \Delta t} + \lambda_p N_p^0 \left( \frac{1}{\lambda_d - \lambda_p} \right) (e^{-\lambda_p \Delta t} - e^{-\lambda_d \Delta t})$$

- Because  $A = \lambda N$ , multiplying by  $\lambda_d$  yields

$$A_d^1 = A_d^0 e^{-\lambda_d \Delta t} + A_p^0 \left( \frac{\lambda_d}{\lambda_d - \lambda_p} \right) (e^{-\lambda_p \Delta t} - e^{-\lambda_d \Delta t})$$

- This expression describes progeny ingrowth in a radionuclide over time and accounts for both decay and ingrowth of the parent and progeny



## Progeny Activity for Supported Decay/Ingrowth (cont.)

$$A_d^1 = 0 + A_p^0 \left( \frac{\lambda_d}{\lambda_d - \lambda_p} \right) (e^{-\lambda_p \Delta t} - e^{-\lambda_d \Delta t})$$

- If no decay progeny were present at  $t_0$ , the term for decay of unsupported progeny present drops out
- This part of the equation describes the ingrowth of decay progeny

# Radioactive Equilibria

- Parent-progeny relationships in a decay chain establish what are referred to as radioactive equilibria
  - Secular Equilibrium
  - Transient Equilibrium
  - No Equilibrium
- These equilibria have characteristics determined by the relative half-lives of the parent and progeny pairs

# Secular Equilibrium $^{226}\text{Ra}$ and $^{222}\text{Rn}$

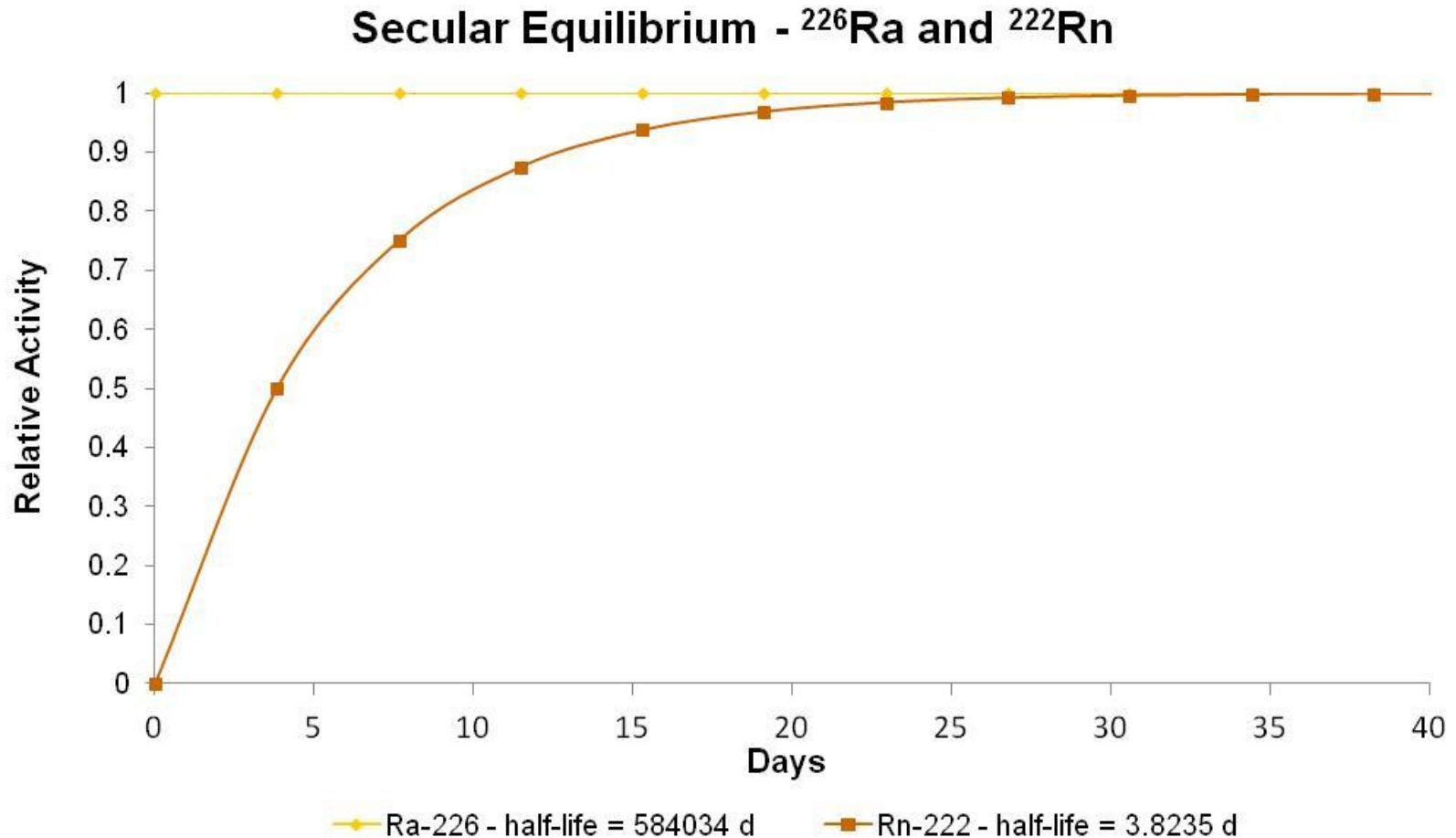

# Ratio of Progeny and Parent Activity at Secular Equilibrium

$$\frac{A_d}{A_p} = \frac{\lambda_d}{\lambda_d - \lambda_p}$$

- When the half-life of the decay progeny is trivial relative to that of the parent (i.e.,  $\lambda_p \ll \lambda_d$ ); the ratio of parent to progeny activity approaches unity

For  $^{226}\text{Ra} - ^{222}\text{Rn}$ ,  $A_d \approx A_p \approx 1$

$t_{1/2} = 5.840 \times 10^5 \text{ d}$	$\lambda_{\text{Ra-226}} = 1.187 \times 10^{-6}$
$t_{1/2} = 3.8235 \text{ d}$	$\lambda_{\text{Rn-222}} = 1.813 \times 10^{-1}$

- Once equilibrium has been attained (i.e.,  $A_d \approx A_p$ ), decay correction can be performed using the parent half-life

# How Long Does It Take to Reach Secular Equilibrium?

$$T_{\max \text{ act}} = \frac{\ln \lambda_p - \ln \lambda_d}{\lambda_p - \lambda_d}$$

$$t_{1/2} = 1600 \text{ y} \quad \lambda_{\text{Ra-226}} = 1.187 \times 10^{-6} \text{ d}^{-1}$$

$$t_{1/2} = 3.8235 \text{ d} \quad \lambda_{\text{Rn-222}} = 1.813 \times 10^{-1} \text{ d}^{-1}$$

For  $^{226}\text{Ra} - ^{222}\text{Rn}$ ,  $T_{\max \text{ act}} = 65.8 \text{ days}$

Secular equilibrium is effectively attained before the theoretical maximum of progeny activity because the curve asymptotically approaches its maximum after ~6–10 half-lives of the progeny.

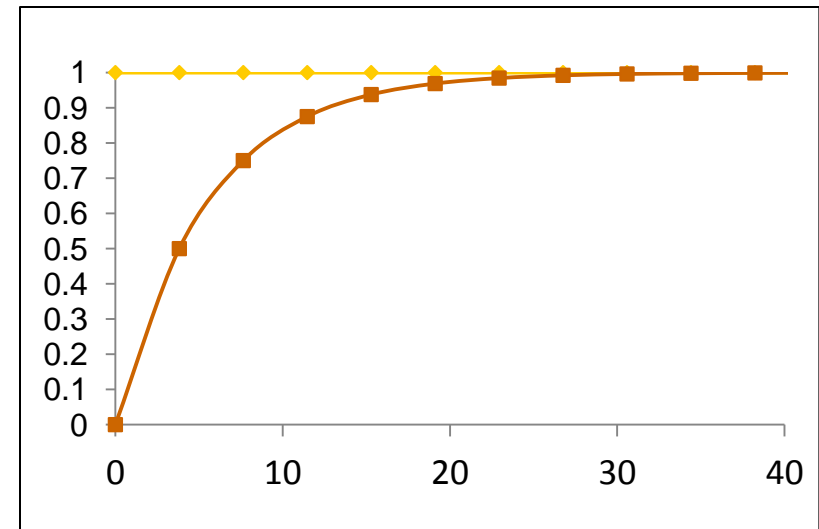

# Only If Secular Equilibrium Is Attained Before the Reference Date...

...can gamma software routines for unsupported decay be used to calculate progeny activity:

- “Trick” the software by building a library where the half-life of the progeny equals that of the parent
- *One size does not fit all!* Libraries must account for conditions specific to the case
- Library values will deviate from published nuclear data
  - Document all assumptions and data used in SOPs/QM
  - Qualify data as appropriate
  - Disclose assumptions and potential limiting conditions in the data package

# Are You Ready to Defend Your Assumptions?

Look at your measurement!

- Is the ratio of progeny/parent activity at the time of the count consistent with secular equilibrium ( $A_p \approx A_d$ )?
- Could differences in physical or chemical properties of the parent or progeny, or other conditions, challenge assumptions of secular equilibrium?
- Were conditions prior to collection stable for long enough to assume equilibrium?

# If Secular Equilibrium Is Not Yet Attained

- The Bateman equation can be used to manually calculate progeny activity at a prior reference date from the activity at the time of count
- This presupposes that:
  - Equilibrium had *not* been achieved at the time of the count, and
  - The sample has been preserved adequately since the reference date (no loss of parent or progeny)



# Secular Equilibrium: Manual Calculation of Progeny Activity at a Prior Reference Date

$$A_d^0 = \frac{A_d^1 - A_p^0 \left( \frac{\lambda_d}{\lambda_d - \lambda_p} \right) (e^{-\lambda_d \Delta t} - e^{-\lambda_p \Delta t})}{e^{-\lambda_d \Delta t}}$$

The activity of decay product at  $t_0$  can be calculated from a single measurement of the sample

- Rearrange the equation for supported decay to obtain an expression for progeny activity at the reference date
- Decay correct the measured parent activity using the parent half-life to determine its activity at  $t_0$
- Substitute activities into equation to calculate progeny activity at the reference date

# Decay Correction Not Possible When Too Much Time Has Passed

- If the parent-progeny pair was not (or may not have been) in equilibrium at the reference date but was in equilibrium at the time of the count, it is not generally possible to determine the progeny activity at the reference date
- Contact the customer, and explain that technical issues prevent you from determining the progeny activity at a prior date

# Transient Equilibrium

- The ratio of decay product to parent activity at equilibrium is described by the equation:

$$\frac{A_d}{A_p} = \frac{\lambda_d}{\lambda_d - \lambda_p}$$

- Transient equilibrium occurs as the half-lives of the decay product and parent converge
- Rule of thumb:

$$t_{1/2 \text{ progeny}} < t_{1/2 \text{ parent}} < 100 \times t_{1/2 \text{ progeny}}$$

# Transient Equilibrium of $^{95}\text{Zr}$ and $^{95}\text{Nb}$

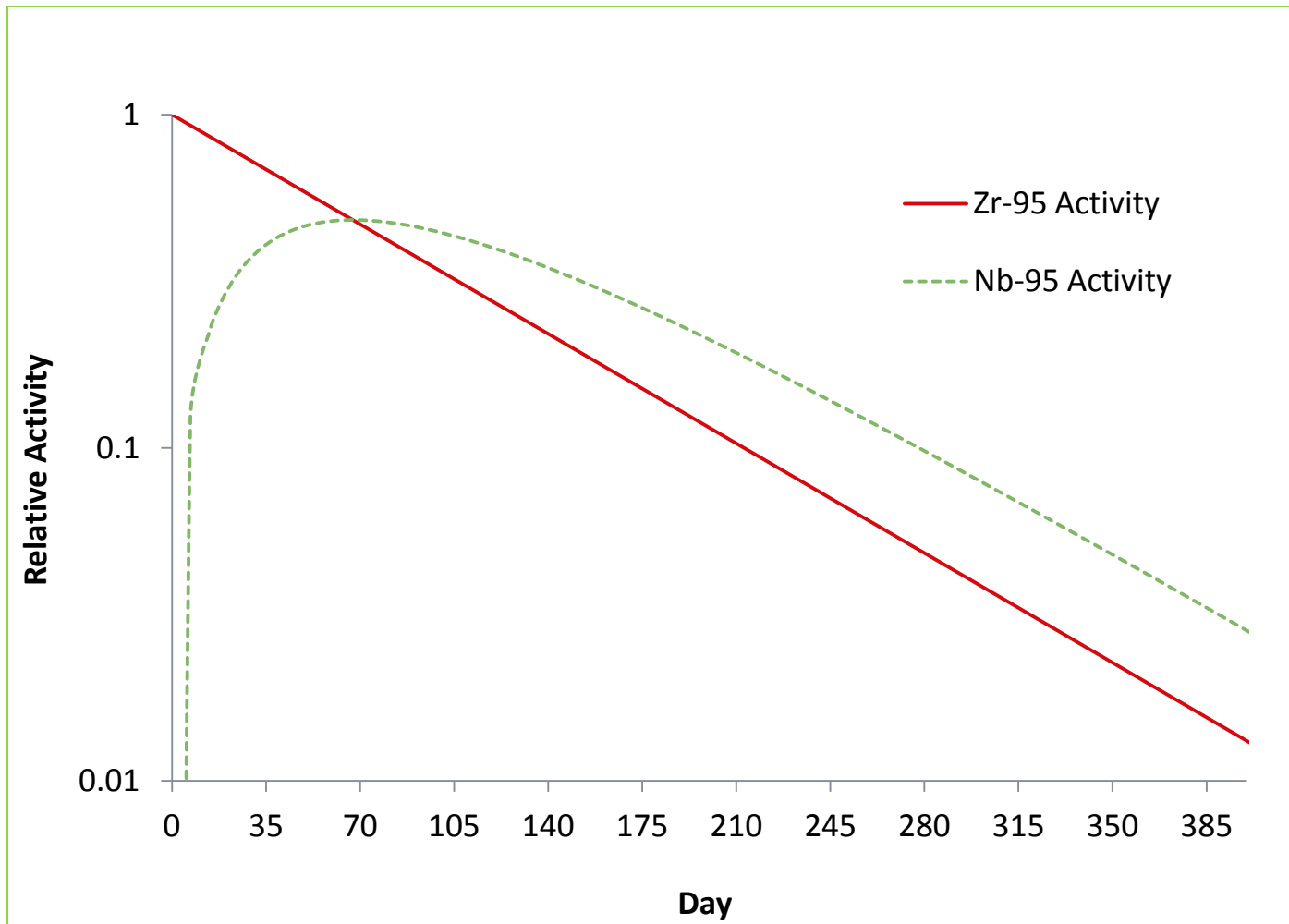

# Transient Equilibrium and the Ratio of Progeny to Parent

$$\frac{A_d}{A_p} = \frac{\lambda_d}{\lambda_d - \lambda_p}$$

- As the denominator decreases in size, the ratio  $A_d/A_p$  becomes larger. At a ratio of 100:1,  $A_d/A_p = 1.01$
- At equilibrium, the decay product activity exceeds the parent activity by a ratio characteristic of the pair
- For  $^{95}\text{Zr} - ^{95}\text{Nb}$  at equilibrium:  $A_d/A_p = 2.205$ 

$$t_{1/2} = 64.032 \text{ d} \quad \lambda_{\text{Zr-95}} = 1.083 \times 10^{-2} \text{ d}^{-1}$$

$$t_{1/2} = 34.991 \text{ d} \quad \lambda_{\text{Nb-95}} = 1.981 \times 10^{-2} \text{ d}^{-1}$$

# When is Transient Equilibrium Achieved?

- Transient equilibrium is never “achieved,” rather the progeny decay curve approaches a parallel to the parent decay curve
- The slope of the curve at  $T_{\max \text{ act}}$  is zero.
  - $T_{\max \text{ act}}$  is not the beginning of equilibrium
  - Applying an unsupported decay correction will bias result
- The time required to equilibrium depends on
  - Half-lives/decay constants, and
  - Whether progeny activity was present at  $T_0$ .

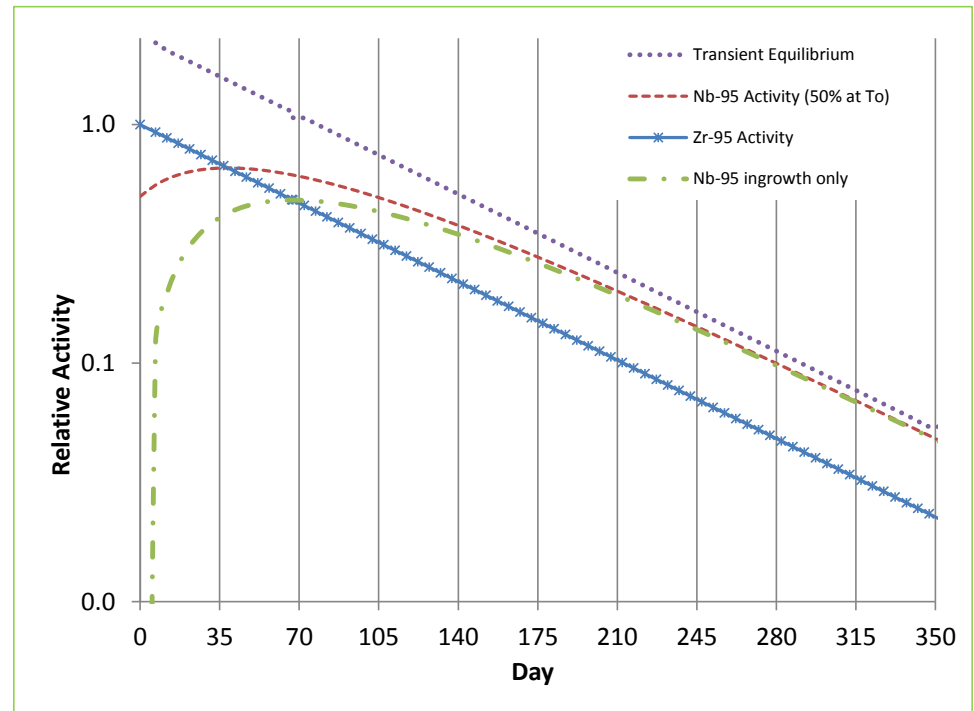

# How Do You Define Transient Equilibrium at Your Lab?

- Develop guidelines for different radionuclide pairs. When is the onset of transient equilibrium?
- Possible examples include:
  - Testing the ratio of progeny to parent activity
    - The ratio of progeny to parent activity is consistent with transient equilibrium
    - Multiple counts may be needed if this is not the case
  - Enough time passed to declare equilibrium

# When Transient Equilibrium Has Been Achieved Prior to the Reference Date...

...decay corrections can be done using routine gamma software algorithms for unsupported decay correction

- Trick the software by building a library customized that uses the half-life of the parent for both the parent and progeny
- Document all assumptions made in SOPs!
- Disclose all assumptions in the data package!



# There Are Cases Where Manual Decay Corrections May be Needed

- If transient equilibrium has not been attained at the sample count, and the progeny-parent activity ratio differs from the expected ratio, one of two conditions may exist:
  - Progeny activity is too high
    - Activity may be from unsupported progeny that was present at  $t_0$
    - Parent activity may have been lost in handling or chemically sequestered prior to collection
  - Progeny activity is too low
    - Progeny may have been lost due to chemical/physical processes
- Showstopper if disequilibrium occurs during/after sampling (i.e., sample is non-representative)

# Transient Equilibrium: Manual Calculation of Progeny Activity at Prior Reference Date

$$A_d^0 = \frac{A_d^1 - A_p^0 \left( \frac{\lambda_d}{\lambda_d - \lambda_p} \right) (e^{-\lambda_p \Delta t} - e^{-\lambda_d \Delta t})}{e^{-\lambda_d \Delta t}}$$

The activity of decay product at  $t_0$  can be calculated from a single measurement of a (well-preserved) sample.

- Rearrange the equation for supported decay to obtain an expression for progeny activity at the reference date
- Decay correct the measured parent activity using the parent half-life to determine its activity at  $t_0$
- Substitute activities into equation to calculate progeny activity at the reference date

# What is No Equilibrium?

- Occurs when the half-life of the parent is less than the half-life of the progeny
  - No constant ratio of parent and decay product activities will ever be established
  - The parent decays with its characteristic half-life
  - After  $\sim 10+$  half-lives, the parent has decayed away
- As the parent activity dwindles, the activity of the progeny increases to a maximum and then decays with its characteristic half-life

# No Equilibrium: $^{147}\text{Nd}$ and $^{147}\text{Pm}$

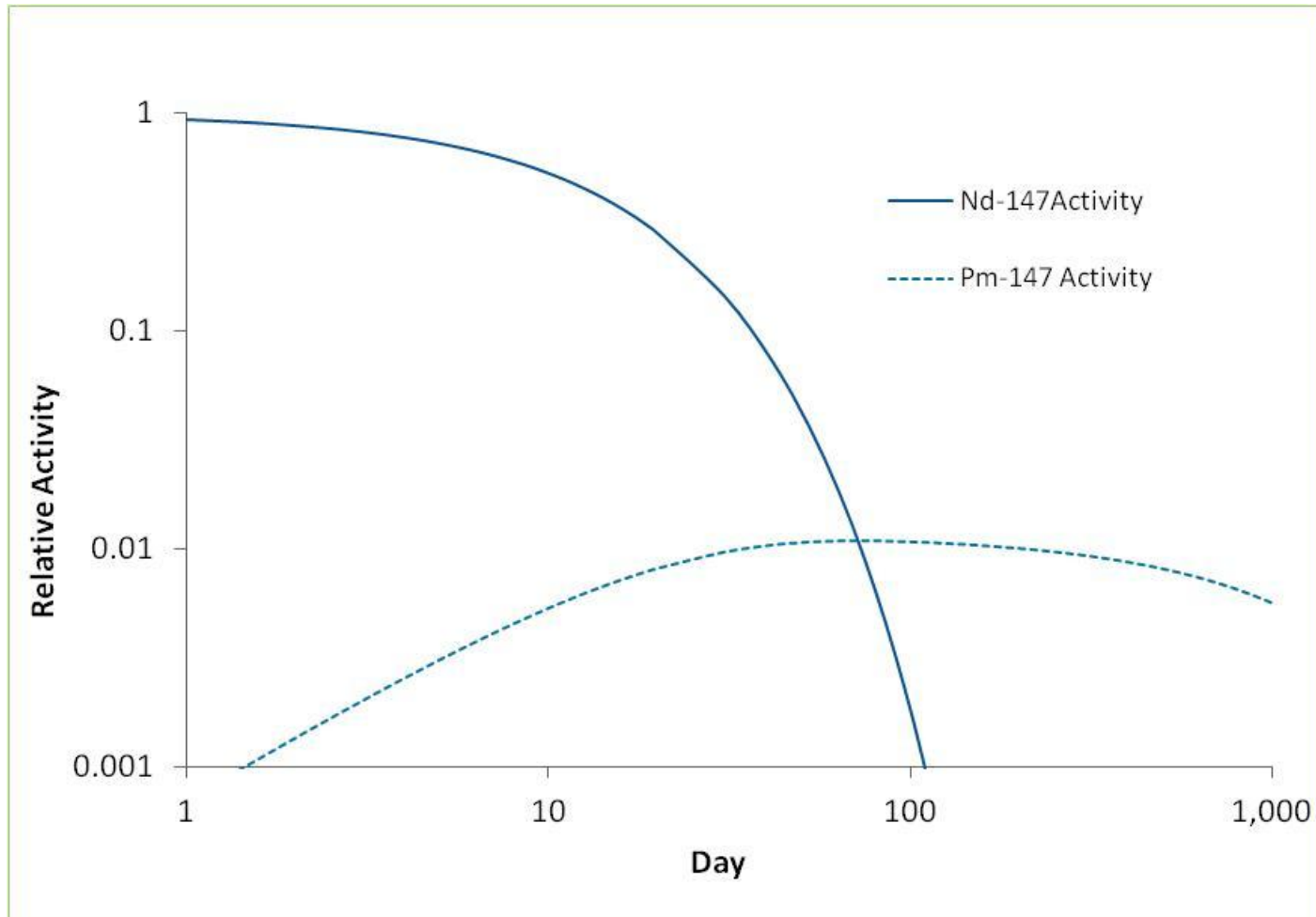

# No Equilibrium: Decay Correction

$$A_d^1 = A_d^0 e^{-\lambda_d \Delta t} + A_p^0 \left( \frac{\lambda_d}{\lambda_d - \lambda_p} \right) (e^{-\lambda_p \Delta t} - e^{-\lambda_d \Delta t})$$

- Until it disappears, the parent activity can be corrected for unsupported decay using its characteristic half-life
  - A similar approach to that used for manual decay correction for transient equilibrium can be used as long as  $t_0$  is known and parent can still be measured
- After the parent has decayed:
  - Corrections for unsupported decay of progeny can be applied
  - The decay correction should not calculate the activity to a time before the maximum activity is achieved because the resultant value would be greater than what would have been possible

# Summary of Fresh Fission Product Equilibria and Some Approaches to Decay Correction

Radionuclide Pair	$\lambda$ Parent (d <sup>-1</sup> )	$\lambda$ Progeny (d <sup>-1</sup> )	Type of Equilibrium	Time to Peak Progeny Activity (Days) <sup>[1]</sup>	Progeny: Parent Activity Ratio Post Equilibrium	Decay Correction Post Equilibrium
<sup>95</sup> Zr/ <sup>95</sup> Nb	1.08E-02	1.98E-02	Transient	67.3	2.20	$\lambda$ Parent + Equation
<sup>99</sup> Mo/ <sup>99m</sup> Tc	2.52E-01	2.77E+00	Transient	0.952	0.96	$\lambda$ Parent
<sup>140</sup> Ba/ <sup>140</sup> La	5.44E-02	4.13E-01	Transient	5.65	1.15	$\lambda$ Parent
<sup>106</sup> Ru/ <sup>106</sup> Rh	1.86E-03	1.99E+03	Secular	0.00697	1.00	$\lambda$ Parent
<sup>132</sup> Te/ <sup>132</sup> I	2.16E-01	7.25E+00	Transient	0.499	1.03	$\lambda$ Parent
<sup>131</sup> I/ <sup>131m</sup> Xe	8.64E-02	5.85E-02	No	14.0	n/a	$\lambda$ Progeny + Equation
<sup>137</sup> Cs/ <sup>137m</sup> Ba	6.31E-05	3.91E+02	Secular	0.0400	1.00	$\lambda$ Parent
<sup>147</sup> Nd/ <sup>147</sup> Pm	6.31E-02	7.23E-04	No	71.6	n/a	$\lambda$ Progeny + Equation
<sup>143</sup> Ce/ <sup>143</sup> Pr	5.04E-01	5.11E-02	No	5.06	n/a	$\lambda$ Progeny

[1] These times are calculated using the expression for the maximum progeny activity  $(\ln \lambda_1 - \ln \lambda_2)/(\lambda_1 - \lambda_2)$ . This is not the effective time to equilibrium (e.g., 99% of maximum) which depends on the decay constants of the parent and progeny, and whether progeny activity is present at  $T_0$ .

[2] <sup>99</sup>Mo/<sup>99m</sup>Tc ratio assumes that only 89 of 100 <sup>99</sup>Mo decays are to <sup>99m</sup>Tc.

# Decay During the Count

- The count rate (activity) for a counting period can be corrected to the beginning of the count period as follows:

$$A_{start} = A_{average} \frac{\lambda t}{1 - e^{-\lambda \times \Delta t}}$$

t is the duration of the sample count (real time)

- When the half-life is greater than twice the count duration, decay correction from the start of the count to count midpoint will yield results within 0.5% of this formula

**Beware!** Do not use this formula in spreadsheets / calculators for extremely long-lived radionuclides (e.g.,  $^{238}\text{U}$ ,  $^{232}\text{Th}$ ) as round-off errors will produce erratic results!

# Calibrations

Standards and traceability

Matrix issues

Calibrations for energy, shape and efficiency

Mathematically based techniques as tools in the efficiency calibration process



# Calibration Standard Characteristics

- Calibration standards should be traceable to national/international standards laboratories
- Certified lines span the energy range to be used
- Carefully matched to sample shape, size, and positioning on detector, density and composition
- Activity homogeneously distributed in sample
- Need fresh standards to adequately fit curve
- Highly accurate calibrations are also possible with single nuclides (no curve fitting)

CERTIFICATE OF CALIBRATION								
Standard Radionuclide Source								
76268-801								
400 mL Simulated Vegetation in HDPE Hi-Plas Container								
<b>Customer:</b>	Washington - State of/Department of Health			ROB-003-04 xw				
<b>P.O. No.:</b>	L109002, Item 3							
<b>Calibration Date:</b>	01-Oct-2007	12:00 EST	<b>Grams of Master Source:</b>	0.0086233				
This standard radionuclide source was prepared using aliquots measured gravimetrically from master radionuclide solutions. Calibration and purity were checked using a germanium gamma spectrometer system. At the time of calibration no interfering gamma-ray emitting impurities were detected. The gamma-ray emission rates for the most intense gamma-ray lines are given. Analytics maintains traceability to the National Institute of Standards and Technology through a Measurements Assurance Program as described in USNRC Regulatory Guide 4.15, Revision 1, February, 1979, and compliance with ANSI N42.22-1995, "Traceability of Radioactive Sources to NIST."								
Nuclide	Gamma-Ray Energy (keV)	Half-Life, Days	Master Source* yps/gram	This Source yps	Uncertainty, %			Calibration Method
					u <sub>A</sub>	u <sub>B</sub>	U	
Am-241	59.5	157860	—	9.960E+02	0.3	1.5	3.1	4π LS
Cd-109	88.0	462.60	1.726E+05	1.488E+03	0.9	1.7	3.8	HPGe
Co-57	122.1	271.79	9.123E+04	7.867E+02	0.5	1.3	2.8	HPGe
Ce-139	165.9	137.6	1.276E+05	1.100E+03	0.5	1.1	2.4	HPGe
Sn-113	391.7	115.1	1.779E+05	1.534E+03	0.6	1.1	2.5	HPGe
Cs-137	661.7	10983	1.147E+05	9.894E+02	0.8	1.2	2.9	HPGe
Y-88	898.0	106.6	4.366E+05	3.765E+03	0.7	1.1	2.6	HPGe
Co-60	1173.2	1925.4	2.159E+05	1.862E+03	0.8	1.1	2.7	HPGe
Co-60	1332.5	1925.4	2.160E+05	1.862E+03	0.9	1.1	2.8	HPGe
Y-88	1836.1	106.6	4.622E+05	3.986E+03	0.5	1.1	2.4	HPGe

\* Master Source refers to Analytics' 7-isotope mixture without Hg-203 which is calibrated quarterly.

**Calibration Methods:** 4π LS - 4 pi Liquid Scintillation Counting, HPGe - High Purity Germanium Gamma-Ray Spectrometer, IC - Ionization Chamber. **Uncertainty:** U - Relative expanded uncertainty, k = 2. See NIST Technical Note 1297, "Guidelines for Evaluating and Expressing the Uncertainty of NIST Measurement Results."

240 grams coffee grounds.

This standard will expire two years after the calibration date.

Source Prepared by: *[Signature]*

# Counts, Peaks, Centroids, MCA

- A gamma peak consists of multiple events or “counts” sorted according to the amplitude of registered voltage pulses
  - Stored channel-by-channel in a multichannel analyzer (MCA)
  - Pulse height is proportional to FEP energy for each gamma ray detected
- Peak centroid
  - Center of mass of the peak (may fall between channels due to peak fitting)
  - Equal numbers of counts on either side of peak

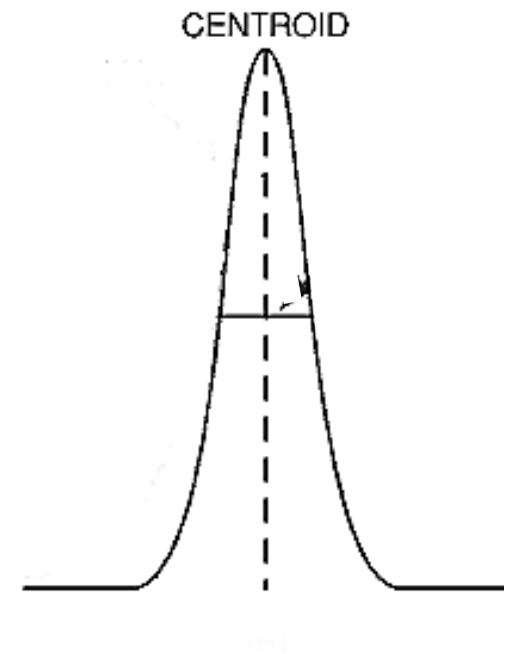

# Energy Calibration

- Establishes the relationship between the location (channel) of the peak centroid and gamma-ray energy
  - Highly linear and generally accurate beyond standard's range
- Energy is used as a basis for identification of radionuclides
  - Software compares location of observed peak centroids to characteristic library energies for radionuclides
  - Energy calibration often used as basis for shape and efficiency calibrations

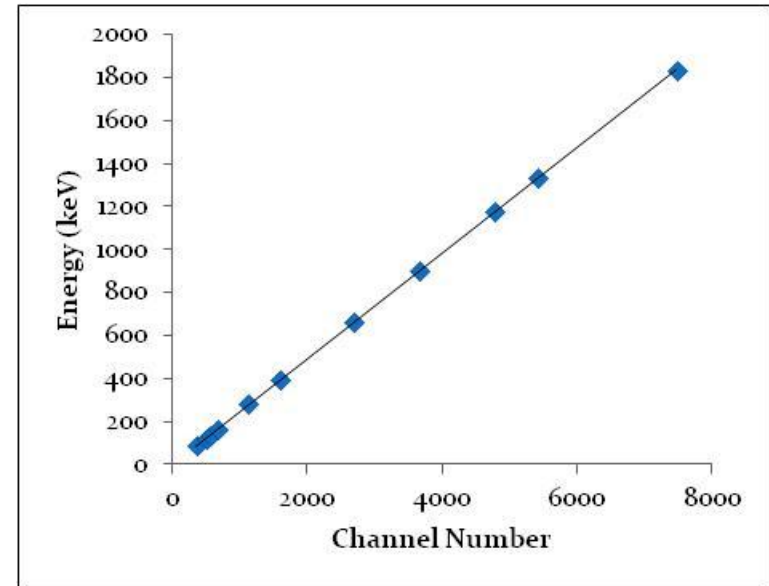

# What is Peak Shape?

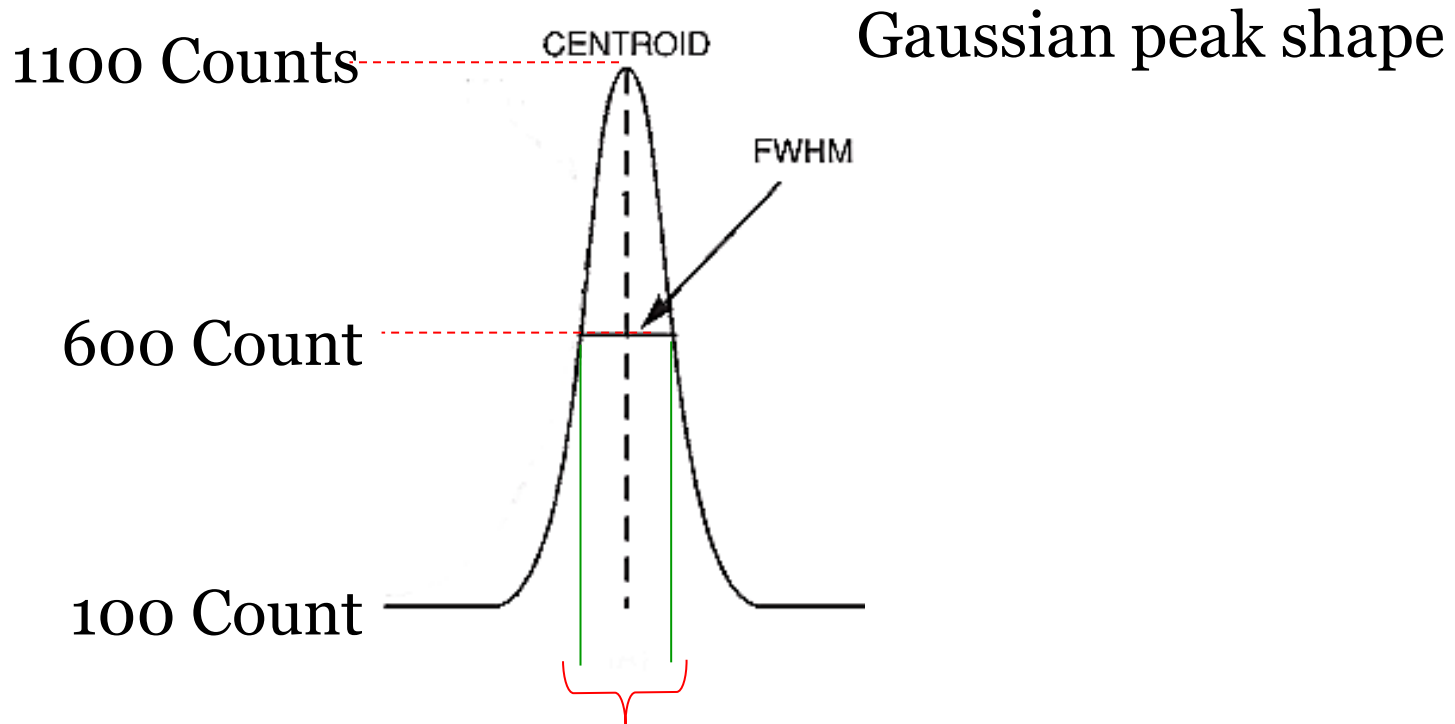

- Full-width-at-half-maximum (channels or energy)
- Resolution,  $R = \text{Centroid}/\text{FWHM}$  (percent)

# Peak Shape (a.k.a. Resolution) Calibration

- Establishes the relationship between energy and full-width-at-half-maximum (FWHM)
- Software finds centroid and fits peaks based on shape calibration
- Multiplet peaks (overlapping peaks) can be resolved by starting with the most prominent centroid, fitting a peak using shape calibration, subtracting fitted peak area, and repeating until activity accounted for

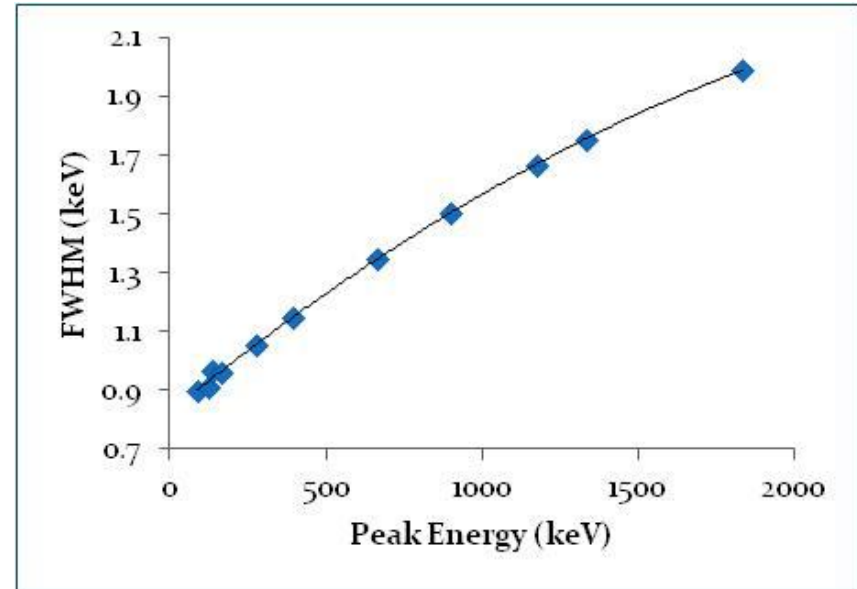

# Efficiency (for Gamma Spectrometry)

$$\varepsilon_E = \frac{R_{n-E}}{Act_E} = \frac{c / \text{sec}}{\gamma / \text{sec}}$$

Where:

$\varepsilon_E$  = the detector efficiency at energy  $E$

$R_{n-E}$  = net peak area for calibration peak (e.g., counts / sec)

$Act_E$  = the gamma emission rate of the calibration standard at energy  $E$  at the time of the measurement (e.g.,  $\gamma$  / sec)

*Note: varies from approach used to calculate efficiency for most radiochemical tests where count rate is divided by disintegration rate of the radionuclide being determined. The isotopic abundance of each gamma ray must be applied when calculating results.*

# Efficiency Calibration

- Establishes the relationship between energy and efficiency for the geometry being counted
  - Count rate relative to the gamma emission rate
  - Often reported in percent (%) or as a decimal
- Used during analysis to relate the count rate of an unknown sample to activity in the source
  - Very specific to sample/calibration standard geometry
  - Efficiency is highly linear with respect to activity until there is high activity in the sample (differs from stable chemistry calibrations curves where standard concentrations vary)

# Gamma Ray Detection Efficiency Density/Composition

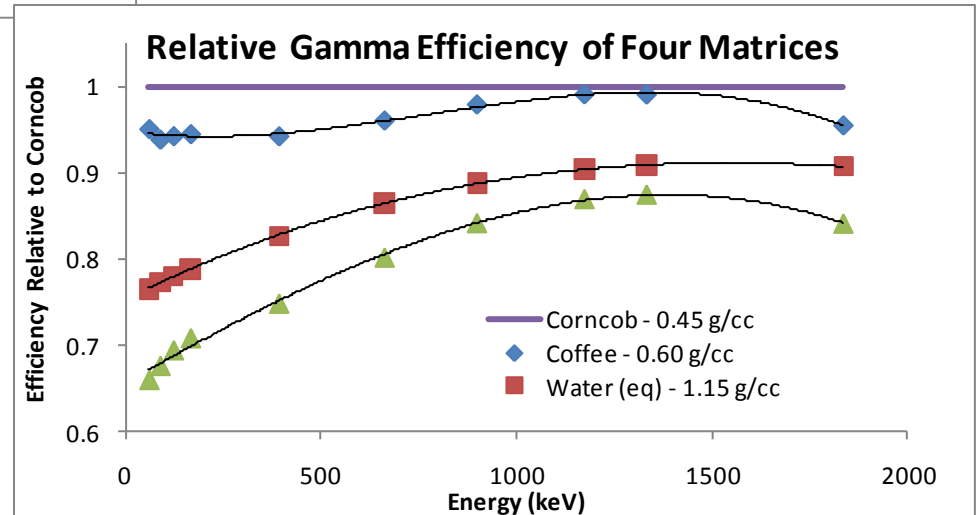
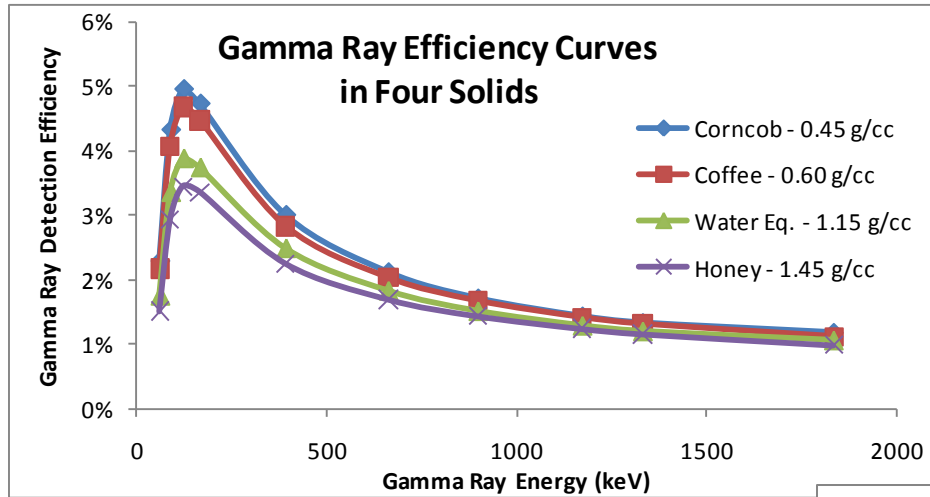



# What is Involved Calibrating a Gamma Spectrometer?

- Obtain calibration standard matched to sample geometry
- Position standard reproducibly on detector
- Acquire spectrum with  $>10,000$ - $20,000$  counts per calibration peak (to minimize uncertainty)
- Perform peak search and analysis to determine peak centroid, FWHM, and peak area
- Fit energy, shape, efficiency data to calibration curves
- Evaluate calibration data using pre-established criteria
- Verify prior to use by analyzing independent calibration standard in same geometry

# Mathematically-Based Techniques as Tools in the Efficiency Calibration Process

- Increasingly accessible to a wider circle of users
  - Sometimes referred to as “standardless calibration”
  - Need good knowledge of detector & source characteristics
  - Process to be used and traceability of approach is debated
- A valuable and powerful tool when used judiciously
  - Calibrate detector with traceable reference standards
  - Develop corrections to account for *minor* differences in calibration and sample geometries (e.g., density, elemental composition, container fill height, etc.)
- Always validate methods/procedures prior to use!
- Perform QC that provides clear, empirical evidence of the accuracy and reliability of the method used!

# How Does Calibration Fit into the Overall Process?

So, the overall analysis process looks like this:

1. Establish calibrations (energy, shape, resolution)
2. Acquire data from sample (count unknown)
3. Evaluate spectrum for peaks (peak search)
4. Match peaks to nuclear data (nuclide identification)
5. Resolve interferences, complete nuclide identification
6. Determine activity based on peak area (quantification)
7. Report results

**More Details Needed? Consult ASTM D7282, “Standard Practice for Set-up, Calibration, and Quality Control of Instruments Used for Radioactivity Measurements”**

# Gamma Spectrometry References

1. G. Gilmore, “Practical Gamma Ray Spectrometry,” 2<sup>nd</sup> Edition, John Wiley and Sons (2008)
2. G. Friedlander, J. W. Kennedy, E. S. Macias and J. M. Miller, “Nuclear and Radiochemistry”, John Wiley and Sons (1981).
3. G. Knoll, “Radiation Detection and Measurement”, John Wiley and Sons (1979)
4. Multi Agency Radiological Laboratory Analytical Protocols (MARLAP) Manual, NUREG-1576, EPA 402-B-04-001A (July 2004)
5. ANSI N42.14, American National Standard for Calibration and Use of Germanium Spectrometers for the Measurement of Gamma-Ray Emission Rates of Radionuclides
6. ASTM D3649, Standard Test Method for High-Resolution Gamma-Ray Spectrometry of Water
7. ASTM D7282, Standard Practice for Set-up, Calibration, and Quality Control of Instruments Used for Radioactivity Measurements.
8. Interactive Chart of the Nuclides, <http://www.nndc.bnl.gov/chart/>
9. NUDAT Decay Radiation Data look-up, [http://www.nndc.bnl.gov/nudat2/indx\\_dec.jsp](http://www.nndc.bnl.gov/nudat2/indx_dec.jsp)
10. Le Laboratoire National Henri Becquerel, Table of Radionuclides, Recommended Data [http://www.nucleide.org/DDEP\\_WG/DDEPdata.htm](http://www.nucleide.org/DDEP_WG/DDEPdata.htm)
11. Gamma Ray Spectrometry Catalogs <http://www.inl.gov/gammaray/catalogs/catalogs.shtml>

Questions?

# Future NAMP Radiochemistry Webinars

- Gamma Spectrometry Part 2 (September 26)
- Overview of EPA Rapid Methods (October 24)
- Subsampling (November 14)
- Mass Spectrometry (December 12)
- Guide to Uncertainty Measurement (January 23)
- Visit NAMP website at [www.wipp.energy.gov/namp](http://www.wipp.energy.gov/namp)